



Federal Aviation
Administration

BASIC SURVIVAL SKILLS for Aviation



**Office of Aerospace Medicine
Civil Aerospace Medical Institute
Aerospace Medical Education Division**

http://www.faa.gov/pilots/training/airman_education

OK-06-033

BASIC SURVIVAL SKILLS FOR AVIATION

***OFFICE OF AEROSPACE MEDICINE
CIVIL AEROSPACE MEDICAL INSTITUTE
AEROMEDICAL EDUCATION DIVISION***

INTRODUCTION

Welcome to the Civil Aerospace Medical Institute (***CAMI***). CAMI is part of the FAA's Office of Aerospace Medicine (***OAM***). As an integral part of the OAM mission, CAMI has several responsibilities. One responsibility tasked to CAMI's Aerospace Medical Education Division is to assure safety and promote aviation excellence through aeromedical education. To help ensure that this mission becomes reality, the Aerospace Medical Education Division, through the Airman Education Programs, established a one day post-crash survival course.

This course is designed as an ***introduction*** to survival, providing the basic knowledge and skills for coping with various survival situations and environments. If your desire is to participate in a more extensive course than ours you will find many highly qualified alternatives, quite possibly in your local area.

Because no two survival episodes are identical, there is no "***PAT***" answer to any one-survival question. Your instructors have extensive background and training, and have conducted basic survival training for the military. If you have any questions on survival, please ask. If we don't have the answer, we will find one for you.

Upon completion, you will have an opportunity to critique the course. Please take the opportunity to provide us with your thoughts concerning the course, instructors, training aids. This will be your best opportunity to express your opinion on how we might improve this course.

Enjoy the course.

(18) A survival kit, appropriately equipped. Some of the items which could be included in the survival kit are:

- (i) Triangular cloths.
- (ii) Bandages.
- (iii) Eye ointments.
- (iv) Water disinfection tablets.
- (v) Sun protection balsam.
- (vi) Heat retention foils.
- (vii) Burning glass.
- (viii) Seasickness tablets.
- (ix) Ammonia inhalants.
- (x) Packets with plaster.

/s/

William T. Brennan
Acting Director of Flight Standards

injury that causes the pain. If the pain persists, keep your mind busy by doing the work necessary to be rescued.

Thirst and Hunger - For the body and mind to function normally, it must have food and water. Water is essential to survival. Life expectancy without water, in extreme conditions, is three days. Even when you are mildly dehydrated, mental skills decrease. When you feel thirsty, you are already dehydrated. If you get into the aircraft thirsty, then you are also going into your survival experience dehydrated. By entering the aircraft already hydrated, you can prevent this.

When dealing with hunger, it is important to remember that the average person can survive 30 days without food. Human beings are creatures of habit. We have established our eating schedule over many years (*breakfast: 6 - 8 a.m., lunch: 11 a.m. - 1 p.m., dinner: 5 - 8 p.m.*). During a survival episode, when these established times are upon you, the body is expecting to be fed. The expectation can be overwhelming. Try to keep your mind off food by doing the things necessary to be rescued.

Cold and Heat – Most survival skills begin with common sense. If you step outside and it is cold, you simply seek a warm shelter. The shelter may come in the form of a jacket or simply re-entering the aircraft. Either way, you have solved the problem.

Fatigue and Sleep Deprivation - Fatigue exist in two forms: physical fatigue and mental fatigue. Each form of fatigue will hasten the onset of the other (*whole body concept*). Physical fatigue stems from overexertion. The best remedy is prevention. Pace yourself and take frequent rest breaks. Mental fatigue is caused by the stress placed upon the mind. One remedy for this is to routinely take your mind off your situation. The best remedy for fatigue is rest and sleep. If you are fatigued, the best thing to do is sleep. When sleeping, the muscles relax and the body unwinds. Also it is believed that during sleep the mind releases useless information and resets your biological clock. Sleep may be difficult in this new environment, however, if sleep is put off even for a day, you will become fatigued.

Depression – Psychologically, this is potentially the biggest obstacle that you as a survivor will have to overcome. You, or anyone in your group, who are suffering from depression will experience long periods of sadness or negative feelings. If you let depression progress it can create feelings of fear, guilt, and helplessness. This may lead to a loss of interest in the basic needs for life. Depression usually occurs after a person has fulfilled their basic needs, and when there is plenty of “down” time. Keep your mind busy with productive thoughts, such as signaling or improving your shelter.

There are many reactions to stress, and they will vary from person to

person. Fear, anxiety, panic, boredom and helplessness are all common emotions experienced in a survival situation. If you don't keep your emotions under control they can dramatically reduce your chances for survival.

Fear and Anxiety- Fear and anxiety are naturally occurring emotions. Anxiety is simply fear at the subconscious level and is described as a feeling of uneasiness. In this state a person is worried about what *might* happen instead of what *is* happening. If anxiety is not dealt with, it can cause panic. Panic is an irrational state of mind and is counter-productive to a survival situation. Fear is at the conscious level. You know what frightens you. Fear, left undealt with, may turn into panic. You must be in control of your fear. To control fear, you must learn to recognize it. Fear produces symptoms, both physiological and psychological. It is important to remember that the symptoms stem from the body going into the "fight or flight" mode. The chart below list symptoms commonly associated with fear.

PHYSICAL	MENTAL
Quickening of the pulse	Hostile, irritable
Dilation of the pupils	Talkative, speechless
Perspiration of hands, soles of feet	Feelings of unreality
Frequent urination	Laughing - Crying
Dry mouth and throat	Confusion
Butterflies in stomach	Feeling of Flight "Fight or Flight"
Nausea—vomiting	

I-1 PHYSICAL AND MENTAL SYMPTOMS OF FATIGUE

Panic – When faced with danger, individuals tend to panic or freeze. Uncontrollable irrational behavior tends to follow. This will vary, in degree, from individual to individual. Panic is brought on by sudden fear. If not dealt with it can rapidly spread through an entire group.

Once recognized positive action should be taken to control the fear. These positive steps, along with knowledge and training, will enhance your will to survive. Training can help you recognize your reaction to fear. Through training, you should learn to think, plan, and act logically, when confronted with fear.

Boredom and Hopelessness – Boredom may be accompanied by feelings of anxiety, strain, or depression. You should remain mentally focused

- (4) Inflation devices, including hand pumps and cylinders (that is, carbon dioxide bottles), for emergency inflation.
- (5) Safety/inflation relief valves.
- (6) Canopy and appropriate equipment to erect the canopy.
- (7) Position lights.
- (8) Hook type knife, sheathed and secured by a retaining line.
- (9) Placards that give the location of raft equipment and are consistent with placard requirements.
- (10) Propelling devices such as oars, or in smaller rafts, glove paddles.
- (11) Water catchment devices, including bailing buckets, rein-catchment equipment, cups, and sponges.
- (12) Signaling devices including:
 - (i) At least one approved pyrotechnic signaling device.
 - (ii) one signaling mirror.
 - (iii) One spotlight or flashlight (including a spare bulb) having at least two "D" cell batteries or equivalent.
 - (iv) One police whistle.
 - (v) One dye marker.
 - (vi) Radio beacon with water activated battery.
 - (vii) Radar reflector.
- (13) One magnetic compass.
- (14) A 2-day supply of emergency food rations supplying at least 1,000 calories a day for each person.
- (15) One saltwater desalting kit for each two persons the raft is rated to carry or two pints of water for each person the raft is rated to carry.
- (16) One fishing kit.
- (17) One book on survival, appropriate for any area.

AC 120-47 - SURVIVAL EQUIPMENT FOR USE IN OVERWATER OPERATIONS

Department of Transportation
Federal Aviation Administration

6/12/87

Initiated by: AFS-220

1. PURPOSE.

The purpose of this advisory circular is to provide information regarding the survival items that should be carried during aircraft extended overwater operations. This provides one means, but not the only means, for compliance with the pertinent regulations.

2. RELATED FEDERAL AVIATION REGULATIONS (FAR) SECTIONS.

121.339, 121.340, 125.209, and 135.167.

3. BACKGROUND.

While the occurrences of water landings in which aircraft occupants depend on overwater equipment for survival are rare, the possibility does exist. Therefore, information about the items which should be included in overwater equipment is important and is provided here. Additional background information and standards are provided in Technical Standards Orders (TSO) C13e, C69a, C70a, C85, and C91a.

4. DISCUSSION.

The recommended equipment should meet applicable TSO. This equipment includes, but is not limited to, the following:

- a. Life preserver for each occupant of the aircraft.
- b. Rafts or slide/rafts with appropriate buoyancy and sufficient capacity for everyone on board the aircraft and which have a boarding station.
- c. Rafts (and slide/rafts where appropriate) should be equipped with the following:
 - (1) Lines, including an inflation/mooring line with a snaphook, rescue or life line, and a heaving or trailing line.
 - (2) Sea anchors.
 - (3) Raft repair equipment such as repair clamps, rubber plugs, and leak stoppers.

with positive task. If there are multiple survivors, you may split up the equipment, and tasks, into responsibility areas. These responsibilities could include signaling, first aid, water procurement, etc. The key is to continually be working the mind towards positive and productive thoughts.

WILL TO SURVIVE

In any survival situation, there are priorities. These priorities are established based on how long a human can survive without each item. The list below is based on the "Rule of Three's":

Air (3 minutes)
Shelter (3 hours)
Rest (30 hours)
Water (3 days)
Food (30 days)

Where does the "will to survive" fit in? What is the "will to survive?" It has been described as hope, determination, goals and/or a positive mental attitude. The opinions will be as varied as the people making them will. One thing is certain: without a "will to survive", your chances of surviving are greatly diminished.

The "will to survive" is commonly referred to as a desire to live despite seemingly insurmountable mental and (or) physical obstacles. In many cases you or your employer provide the necessary equipment for survival. Training for a survival situation will come from courses, experience, and research. However, equipment and training are not always enough to ensure your survival. You must also have a *will to survive*.

An example of the power of one's "will to survive" can be seen in the following excerpts taken from USAF Regulation 64-5, Volume I, July, 1985.

Stranded without food or water on a vast stretch of the Arizona desert for eight days, a man traveled 150 miles during the day in temperatures as high as 120 degrees. Lack of water caused him to lose 25% of his body weight through dehydration (10% is usually considered fatal). He had crawled the last eight miles completely naked. The lacerations he had suffered did not bleed until he had replaced the water in his system. He had done nothing right because he had no survival training. Yet, one thing this man did have was a strong will to survive, and he did survive through sheer will power.

As a contrast to this man's obvious *will to survive*, the following is an example.

A pilot ran into engine trouble and chose to dead-stick his plane, rather than eject. The aircraft came to rest on a frozen lake with little or no damage. After examining the aircraft for damage and assessing the area he noticed a wooded shoreline that would provide decent shelter. Approximately halfway to the shoreline he decided to return to the aircraft. After re-entering the cockpit, he lit a cigar, and smoked a portion. He then pulled out a pistol, and delivered a fatal shot to the head. Amazingly, less than 24 hours later a rescue team located him.

We may never know what influenced this pilot's decision to end his survival episode early, especially since it looked so promising. On the flip side, we can't really explain why some people will practice extreme measures to insure their survival. An example of these measures was exhibited by the Donner party when they decided to eat human flesh to survive. One thing is for certain, it all relates to the "*will to survive*."

When there seems to be no escape from your situation, and the odds seem against you, the "*will to survive*" can provide you with the spark you need to press on. This positive and productive thinking can help take you from a crisis period into one of coping.

The **crisis period** is the period in which a person realizes the gravity of the situation and begins to understand that it is not going away. At this point you will act, either positively or negatively. Post-crash shock will be a factor on your mental state. At this point you must decide whether to deal with the situation, or succumb to it.

The **coping** period begins after the survivor realizes the gravity of the situation and resolves to endure it rather than succumb to it. This is easier said than done. Remember, there be many factors working against you, such as pain, hunger, fear, and fatigue. You must think constructively at this point so as to prevent fear or panic. One way to deal with this in the immediate aftermath of the accident is to S.T.O.P.

STOP is an acronym for **Sit, Think, Observe, and Plan**. In the immediate aftermath of the accident, you should take a few moments to sit and collect your thoughts. This is a good time to drink some water, as water will help to treat any post crash shock. You can then think about the situation and transition your situation from a crisis to the coping stage. Take this time to observe the area, inventory your survival equipment, and attend to any injuries. Now you are ready to make a plan for your survival.

It is not likely that you will ever schedule a survival situation. The surprise, coupled with the enormity of the situation, can be overwhelming. Through knowledge, and training, you can help yourself prepare for the mental obstacles that are present in all survival situations.

13. Escape hatches should not be removed until the aircraft has come to a complete stop.

(Circle the best answer)

- a. True
- b. False
- c. It depends manufacturers suggested procedures.

14. What is the most important item to secure so that it does not become a projectile?

(Circle the best answer)

- a. Anything that you think will cause bodily harm
- b. All items with jagged edges
- c. You!
- d. Don't worry, the seat will protect you from projectiles

15. The most prevalent medical problems experienced in a tropical environment include:

(Circle the best answer)

- a. Infections and hangnails
- b. Diarrhea and infection
- c. Dehydration and disease from insects
- d. Infected wounds and disease from insects

8. The three types of deserts are:

(Circle the best answer)

- a. Northern, southern, and equatorial
- b. Hot, arid, and temperate
- c. Sand, rock, and salt
- d. Mountainous, flats, and mesas

9. Fill in the blanks. Ration your _____, not your _____

10. Hypothermia is defined as:

(Circle the best answer)

- a. A lowering of the inner-core body temperature
- b. Being exposed to cold temperatures
- c. Decreased breathing due to extreme cold temperatures
- d. Increased breathing due to extreme hot temperatures

11. The act of attracting attention is a good description of:

(Circle the best answer)

- a. Surviving
- b. Will to survive
- c. Signaling
- d. Communication

12. A signal that uses fire, smoke, or ballistics is a:

(Circle the best answer)

- a. Pyrotechnic
- b. Improvised
- c. Both a & b
- d. B only

WILL TO SURVIVE

Self-Appraisal

1. What one word best describes the Will to Survive? _____

2. Are we born with the Will to Survive, or is it acquired? _____

3. In survival, what is the biggest threat to the Will to Survive? _____

4. How strong is your Will to Survive? _____

PSYCHOLOGY OF SURVIVAL

Chapter Quiz

1. For each item below, rate it's value in a survival situation?

Hint: The shorter the time of survival without each item, the higher the value.

- a. _____ Water
- b. _____ Rest
- c. _____ Shelter
- d. _____ Food
- e. _____ Oxygen

2. On which body function does survival place the greatest stress?

(Circle the best answer)

- a. Digestive system
- b. Mental
- c. Circulatory system
- d. Skeletal system

3. When should you begin to hydrate yourself out of concern for a survival situation?

4. Without this, your chances of survival are greatly reduced.

5. Which of the following can enhance your "Will to Survive?"

(Circle the best answer)

- a. Training
- b. Knowledge of your equipment and environment
- c. Knowing yourself and how you react in different situations
- d. Having a positive mental attitude
- e. All of the above

4. The MOD-1 survival kit:

(Circle the best answer)

- a. Designed for four survivors
- b. Designed to provide enough equipment to survive for 72 hours
- c. Weighs approximately 30 pounds
- d. All the above

5. A dual redundancy raft is one that:

(Circle the best answer)

- a. Have two cells to protect against sinking
- b. Have two colors
- c. The top is identical to the bottom
- d. None of the above

6. Three basic elements necessary for fire building are:

(Circle the best answer)

- a. Tinder, kindling and fuels
- b. Oxygen heats and fuel
- c. Pressure, density and temperature
- d. All of the above

7. A fire can provide a survivor with a source of:

(Circle the best answer)

- a. Protection
- b. Light
- c. Warmth
- d. Companionship
- e. All of the Above

QUIZ

1. For each item below, rate it's value in a survival situation.

HINT: The shorter the time of survival without each item, the higher the value.

- a. _____ Water
- b. _____ Rest
- c. _____ Shelter
- d. _____ Food
- e. _____ Oxygen (*respiration & circulation*)

2. On which body function does survival place the greatest stress?

(Circle the best answer)

- a. Digestive system
- b. Mental
- c. Circulatory system
- d. Skeletal system

3. Which organization has the responsibility of all SAR in the 48 contiguous states?

(Circle the best answer)

- a. Civil Air Patrol
- b. U.S.A.F. Reserves
- c. Air Force Rescue Coordination Center
- d. Local law enforcement

1.(E-1, C-2, B-3, A-4, D-5) 2. B 3. C

SEARCH & RESCUE

To begin this chapter, we need to distinguish between two key words: search and rescue. If the rescue party doesn't know where you are, it's a search. If they know where you are, it's a rescue. Responsibility can be broken down into two different areas. If the rescuer doesn't know where you are, then it is your responsibility to tell them (*flight plan, radio call, Emergency Locator Transmitter (ELT), ground to air signals*). If they know where you are, then it's yours and the rescuer's responsibility to get you home (*National Search and Rescue Plan*).

The average time from Last Known Position (*LKP*) to rescue is approximately 27.3 hours. Since this is an average, a survivor could be in a survival scenario for a few hours or a few days. But, no matter how long you are out there, you should be doing everything in your power to accomplish the survival goal: RESCUE. In all actuality, this begins before you step inside the aircraft. By filing a flight plan you are getting some of the best insurance around, and it's free! The type of flight plan that you file (*IFR vs. VFR*) may greatly affect the time you spend in a survival situation.

FLIGHT PLAN	LAST KNOWN POSITION TO NOTIFICATION	LAST KNOWN POSITION TO RESCUE
<i>IFR</i>	<i>1.1</i>	<i>11.5 hours</i>
<i>VFR</i>	<i>4</i>	<i>18 Hours</i>
<i>No Flight Plan</i>	<i>18.5</i>	<i>62.5 Hours</i>

2-1 AVERAGE SEARCH TIME. Information provided by AFRCC(2008) Statistics will be affected by the change from 121.5 MHz to 406 MHz, but are not indicated in these numbers.

Any time an aircraft is overdue, missing, or sends a radio distress call, the National Search and Rescue Plan is activated. Although there are many organizations and volunteers associated with Search and Rescue (SAR), the Federal government assumes overall responsibility. According to this plan, the United States Coast Guard (USCG) is responsible for all maritime rescues and the U.S. Air Force is responsible for inland rescues. All SAR in the 48 states is coordinated through the Air Force Rescue Coordination Center (*AFRCC*), located at Langley AFB, Virginia. The *AFRCC* is on call 24 hours a day.

Although Coast Guard assumes responsibility for all maritime rescues, they have set up a network of merchant ships worldwide. The Auto-

mated Mutual-assistance Vessel Rescue System (AMVERS) works under a cooperative agreement between the USCG and National Oceanic and Atmospheric Administration. AMVERS is a computer system used to track participating merchant vessels at sea. The vessels send information about their locations, intended tracks, communication links, medical facilities and helicopter capabilities via satellite to the AMVERS Database Server at the USCG Operations Systems Center. This allows the Rescue Coordination Centers worldwide to locate vessels near a ship in distress, in order to divert them to render aid. The system is attributed with saving hundreds of lives a year. It also saves taxpayers money since Coast Guard ships and aircraft are often not required. Currently there is an average of nearly 3000 ships a day that participate in the AMVERS system.

The Air Force assumes responsibility for all inland search and rescue; although it is not likely that they will fly the actual missions. According to the AFRCC, over 85% of federal inland search and rescue missions are conducted by the Civil Air Patrol. According to the Civil Air Patrol they save more than 100 lives a year.

THE PROCESS

Even though an aircraft is missing the search may not initiate immediately. The aircraft must first be verified as overdue. This step of the process is dictated by the type of flight plan the pilot in command filed. A Information Request (*INREQ*) is filed by the Flight Service Station servicing the destination airport when:

- An aircraft flying **IFR** is overdue with no communications 30 minutes after ETA to a reporting point. This may be to an enroute point or destination.
- An aircraft flying **VFR** is overdue by 30 minutes after ETA to final destination. NOT to an enroute fuel stop, detour, etc.
- An aircraft filing no flight plan is overdue by one hour, as reported to the FAA by a reliable source. *Aircraft with no flight plan filed compromise 80% of aircraft involved in search and rescue operations.*

Once the aircraft has been verified to be overdue the first of three phases is initiated.

(1) The Uncertainty Phase. During this phase the FAA and the AFRCC conduct a preliminary Communications (*PRECOMM*) search. Because of the high rate of false alarms, this phase is designed to see if the situation is really a missing aircraft or a pilot who didn't close a flight plan. If the *PRECOMM* comes up negative, then the next phase is activated:

4. When is the use of a tourniquet recommended in a survival situation? (Circle the best answer)

- a. Never
- b. Whenever direct pressure does not work
- c. Only as a last resort
- d. Whenever you can

5. How often is it recommended that you open and drain blister on your feet during your survival episode? (Circle the best answer)

- a. Daily
- b. Only when they start to be irritated
- c. Never
- d. Only after long walks

SURVIVAL FIRST AID/SELF AID
Chapter Quiz

1. It is wise to attend a First Aid/CPR certification course how often?
(Circle the best answer)

- a. Every other year
- b. Every four years
- c. Only once
- d. Annually
- e. All of the above

2. Fill in the blanks next to the FIRST AID acronym with the appropriate word:

F _____

I _____

R _____

S _____

T _____

A _____

I _____

D _____

3. If you determine a person has an obstructed airway, what is the recommended method for opening that person's airway?
(Circle the best answer)

- a. Open the airway by tilting the head back
- b. Stick your fingers in the person's mouth and pull on their tongue.
- c. Goose them
- d. All of the above

(2) **The Alert Phase or Alert Notice (ALNOT).** Normally the ALNOT is issued at the end of INREQ, at the estimated time that the aircraft fuel would be exhausted, or when there is serious doubt as to the safety of the aircraft and occupants. During the ALNOT, the destination airport checks all ramps and hangars to locate the aircraft. Local law enforcement in the search area is notified, and all information is sent to AFRCC. If the aircraft is not found during the ALNOT then the third and final phase is activated.

(3) **The Distress Phase.** At this point, the actual search mission is launched. Usually air search efforts will not begin until daylight unless the aircraft is equipped with a functioning ELT (*Electronic Locator Transmitter*) directing a ground rescue party to the general vicinity of the crash site, and if, the weather permits, an ELT also points air rescue to the distress location. Even with a functioning ELT, terrain and weather may hamper response time. The chances are good that you will be spending at least one night as a survivor.

With a functioning ELT, the time you spend awaiting rescue can be drastically cut. Since 1974, all aircraft are required to carry an ELT. Many ELTs have been troubled with unreliability after crashes and a high rate of false alarms. But the bottom line is that ELT's save lives. AFRCC statistics show that the survival rate for crash survivors in remote areas **without** an ELT is reduced by 43%.

The ELT's effectiveness is due in large part to the Search and Rescue Satellite (*SARSAT*) system. The SARSAT system consists of low-orbiting satellite's and ground relays, or Local User Terminals (*LUTS*). The map below shows the locations of LUT's throughout the world.

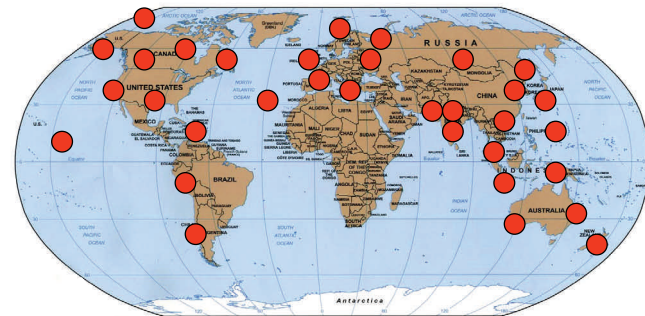

2-2 Location of Local User Terminals

When an ELT is activated, it broadcasts a signal on 121.5 MHz and 243* MHz (*UHF emergency frequency used by military aircraft*). The SAR-

SAT is in constant orbit about the earth, scanning continuously for these signals. It generally takes two passes over the location for the satellite to pinpoint the position. Once the satellite has this information, it relays it to a LUT, which then relays the information to rescue organizations. The SARSAT system can pinpoint a position to within 11 nautical miles. Newer 406 MHz ELTs provide a single-pass capability that can pinpoint a crash site to within one nautical mile.

The 406 MHz Emergency Positioning Indicating Radio Beacon (EPIRB) commenced with the start-up of COSPAS-SARSAT. COSPAS is a Russian acronym for *Cosmicheskaya Sistyema Poiska Avariynich Sudov*, which translated to English means Space System for the Search of Vessels in Distress. The units were designed for satellite detection and Doppler location. The devices are designed to provide:

- Improved location accuracy
- Ability to process a larger number of beacons transmitting simultaneously within view of a satellite
- Global coverage
- Ability to identify a specific beacon

COSPAS-SARSAT transponders are payloads located on weather satellites. USA, Russia, France and Canada maintain these satellites cooperatively. In some cases, with the use of these satellites, the 406 MHz system reduces the location accuracy to as little as 1 nautical miles. The alert is sent instantaneously.

A non-functional ELT can't help you. The U.S. Coast Guard estimates that less than 1/3 of ELTs actually activated in a crash. The SARSAT Mission Control Center suggests that the figure is closer to 12%. When you preflight the aircraft, you should also preflight the ELT. Tune the aircraft's radio to 121.5 MHz, switch the ELT, on, and listen for the swept tone. This can be accomplished **only** within the first five minutes of any hour and you are limited to three sweeps. After any emergency landing, you should eventually go back into the aircraft to ensure the ELT is functioning.

Another problem with ELTs is that they cause false alarms. According to the AFRCC, nearly 98% of all signals detected are false alarms caused by accidental activations of the ELT. The result is that there is always a delay to start the search process until the signal can be validated. Even so, many unnecessary search missions are launched every year, at an estimated annual waste of over \$3.5 million. Of even greater importance to you is the lag time it takes before a call can be considered genuine. This could be the difference between becoming a survivor or a statistic.

The ELT can be activated during a hard landing. For this reason, it is

Note: Tourniquets and cut-and-suck kits are no longer recommended.

➤ Other bites and stings

Lizards



- Only two venomous lizards are found in North American deserts, the Gila monster and the Mexican bearded lizard. Both are relatively sluggish and non-aggressive. There is little chance of being bitten if you watch where you put your hands and feet.
- Treatment is the same as for snakebite. Don't panic and drink lots of fluids.

Scorpions and spiders

- Avoid these critters by keeping your hands out of cracks, crevices, and the underside of rocks, boards, etc. All scorpions and spiders are poisonous to some degree, although human deaths are relatively uncommon. The bites of two spiders, the black widow and brown recluse, are dangerous to humans.

Stinging insects

- In the U.S., bees, wasps, velvet ants, hornets, yellow jackets, etc., cause more deaths than snakes, usually to people who are allergic to them.
- If you are allergic to stings, your physician may recommend that you carry a bee sting kit. Follow the doctor's directions on its use.
- If you are not allergic to stinging insects, treat their stings by:
 1. Scrape the stinger away if it has been left behind. If you try to pull it out you will squeeze the poison sac and increase the dose.
 2. Treat for pain with a cold pack if you can.

Keeping yourself and your camp clean and neat can prevent many survival injuries and illnesses. That sounds trite, but it is true. The chance of getting hurt is greatly lessened when you keep everything in its place and use all your survival tools properly. By merely washing yourself and your clothes frequently, even when that seems like a very low priority item, you can reduce the odds that you will aggravate your survival situation by getting sick.

In conclusion, remember that if you get hurt or ill, in spite of your best efforts, **your ultimate goal is to get home**. That must govern all of your efforts and decisions. With that in mind, it is up to you. Do the best you can to remain calm and provide self-aid/first aid to achieve your goal. **You're the doctor.**

4. Cover the burn with the cleanest dressing you can contrive. Boiled clothing or commercial dressings from a first aid kit are ideal.
5. Pain will be a problem you will have to deal with. If you're not allergic to it, aspirin may help the pain and will help prevent swelling.
6. Be alert for signs of shock. Even if no shock symptoms occur, avoid salt and start drinking more water than you think you could possibly need. Water will help fight shock and will ward off the dehydration that normally follows a burn.

➤ Diarrhea

- Common diarrhea is quite prevalent under survival conditions. It may be caused by nervous tension, by eating unfamiliar foods, or by intestinal infection from contaminated water. In any case, it is uncomfortable at best and debilitating when it is severe. It causes dehydration, which can only be combated by drinking what may seem like an excess of fluids.
- Most incidents of diarrhea are relatively easy to control—even without access to a pharmacy. Just eat fresh (but cool) natural charcoal from your campfire. The taste is not unpleasant since all the pitch and cellulose is burned away. A couple tablespoonfuls will help get you back in control.

➤ Fever

Like pain, fever is a symptom of some other problem, but it can be a survival problem in itself.

1. If you have aspirin, take it according to directions for some relief
2. Drink plenty of fluids, as fever can be a symptom of dehydration.

➤ Snakebite

If you get bitten by a venomous snake and cannot get professional medical attention, your best bet is to:

1. Make every attempt to remain calm
2. Drink plenty of water and
3. Seek professional treatment as quickly as possible
4. Do not rush around—that will increase the circulation of venom in your bloodstream.



a good idea to tune your aircraft's radio to 121.5 MHz and monitor it before running your aircraft shutdown checklist. You should also keep in mind that it is acceptable to test your ELT the first five minutes of any hour.

SEARCH AND RESCUE

Chapter Quiz

1. Which organization has the SAR responsibility in the 48 contiguous states?

(Circle the best answer)

- a. Civil Air Patrol
- b. U.S.A.F Reserves
- c. U.S. Air Force Rescue Coordination Center
- d. Local law enforcement

2. If an aircraft is overdue with no communications, and has filed an IFR flight plan, how long will it take the Flight Service Station to issue an INREQ?

-
3. When should you check, or test, your ELT?

(Circle the best answer)

- a. At some point during your flight
- b. Once a month
- c. Before each flight
- d. Before every other flight

4. What is the correct time to test an ELT.

(Circle the best answer)

- a. Any time
- b. Last 10 minutes of any hour
- c. First five minutes of any hour
- d. First 10 minutes of any hour

5. How do you manually test your ELT? _____

- Secure the object in place and bandage both eyes (*the eyes move together so if only one eye is bandaged, the object will cause more damage*).

➤ **Blisters**

- A blister is essentially a protective reaction over an injury. It should be left intact. Do not open or drain the fluid from blisters. Protect them with a clean dressing or padding.

➤ **Burns**

- Probably no survival injury is as serious or as difficult to deal with as a severe burn. With anything more than a simple first-degree burn (i.e. sunburn), dehydration, and infection are likely to occur in that order. Pain and trauma to the circulatory system near the burn causes shock. Dehydration caused by loss of body fluids in the burned
- Area will require a much higher than normal intake of water. The loss of skin and the favorable conditions for bacterial growth pose a threat of infection that cannot be controlled in a survival situation; however, infection will not likely be a factor for a day or so.
- You are limited as to what can be done for a burn without sterile conditions and some medical gear. As a result, it makes little difference what the medical diagnosis of the severity of your burn might be, you will have to treat them all pretty much the same:
 1. First, cool the burned area. Do not waste time! Plunge the burned part into cold water or anything you have that will chill the injury without further damage (no ice). Cooling prevents further harm from residual heat in the tissues. Unless you quickly get the temperature back down to normal, tissue damage may continue even after the heat source is removed.
 2. Clean the burned area with soap and water (1st & 2nd degree burns), but be gentle. You do not want to compound the injury by disrupting damaged tissue.
 3. Do everything you can to keep the burned area clean and protected. Do not remove charred clothing from the burn site (it is preventing contaminants from getting to the damaged tissues).

splint above and below the fracture site and the joints above and below the fracture as well). Treat any wound in the area prior to applying the splint.

When you have to get around with an injured leg or foot, a cane or crutch is a big help. A padded, forked pole will serve as an emergency crutch.

Dress Wounds

Dressing wounds means going back over the body and cleaning up non-life threatening injuries (i.e. abrasions) and applying dressings to promote healing and prevent infection. This is also a good time to go back to areas where severe bleeding was stopped, add additional material, and retie bandages if needed.

Treatment of Other Wounds Not Previously Mentioned

Types of wounds and treatment are as follows:

➤ Head wounds

- Keep wound area clean and covered.
- Direct pressure is the only way to stop scalp hemorrhage

➤ Eye wounds

Chemical or irritant in eye

- Flush eye with clean water ensuring the injured eye is lower than the healthy eye.
- Keep eye clean and covered

NOTE: NEVER use water, salves or ointments for perforating eye injuries.

➤ Eye Out of Socket

- **DO NOT** try to reinsert the eye as this may cause further damage
- Cover the with soft, moist dressing (*be sure to keep moistened*)
- Bandage loosely in place but provide support.

➤ Object Impaled in Eye

- **DO NOT** remove the object from the eye (*it is plugging the hole*)

SIGNALING

As a potential survivor you will have many options of equipment for use to gain the attention of Search and Rescue professionals. In fact, depending on the device being used, first contact may not even be with Search and Rescue (SAR) personnel. For instance, you may contact a relative by cell phone who then notifies local emergency personnel of your situation. One of the best aids, in terms of helping SAR personnel reduce the time it takes to locate you will be to let someone know your plans. In aviation, filing a flight plan can greatly reduce your survival time until rescue. This chapter will outline various categories of signaling equipment as well as describe some of the features of the more popular devices.

Signaling is simply the act of communicating, conveying knowledge or information from one source to another. For successful communication to occur there must be three basic elements:

- The communicator (*Survivor*)
- The message (*SOS*)
- The receiver (*SAR Personnel*)

To ensure successful communication there can be no breakdown in any one of the elements. This is especially true regarding signaling in a survival situation. However, the survivor must first gain the attention of those in which the communication is intended. In this case the receiver will be the Search and Rescue (SAR) personnel.

When choosing any signaling device you should consider the objective. In most cases you will want to initiate contact with someone, or something. This may be from a remote area where a line of sight device will initially be of no use. You will need a communication device that can signal a great distance such as a satellite phone, survival radio, electronic locator transmitter (ELT), emergency position indicating radio beacon (EPIRB), etc. Once contact is made you will need the capability of directing the SAR personnel to your exact location. These devices can include flares, smoke, reflectors and ground signals.

Signal devices can be divided into various categories. This chapter will divide the signaling equipment into three categories:

- Pyrotechnics (*fire or ballistics*)
- Electronics (*radio's, ELT, etc.*)
- Improvised (*all others*)

PYROTECHNICS

The following information concerning pyrotechnics was taken from the U.S. DOT/FAA Advisory Circular No 91-58A.

Subject: USE OF PYROTECHNIC VISUAL DISTRESS SIGNALING DEVICES IN AVIATION Date: 2/10/00 AC No. 91-58A

1. Purpose. This advisory circular (AC) suggests standards and procedure for the acquisition, use, and storage of pyrotechnic visual distress signaling devices that are intended for use in aircraft emergencies.

2. CANCELTION. AC 91-58, Use of Pyrotechnic Visual Distress Signaling Devices in Aviation, dated 5/27/82, is canceled.

3. BACKGROUND. The Federal Aviation Administration (FAA) recognizes that many pilots and operators of aircraft are utilizing some distress signaling devices that are inherently dangerous, as well as ineffective, when used in actual emergencies. Typical of the problem is the use of “railroad or highway flares,” which produce an excessive amount of high temperature slag, usually burn the user when hand held, and are easily extinguished when used in open bodies of water. Further, the incendiary nature of these and other pyrotechnics presents problems for their safe and proper storage in the aircraft environment. This advisory circular is written to guide the pilot/operator in the proper use of and identification of pyrotechnic signaling devices.

a. **The Safety of Life at Sea (SOLAS) convention**, which was ratified in 1936 by the United States, provides safety standards for maritime emergency survival equipment, fireproofing, fire prevention, and such. The SOLAS convention revises the safety standards every 4 years. The convention ensures that a variety of safe and effective pyrotechnic signaling devices are available to the aviation community.

b. **Title 14 of the Code of Federal Regulations (14 CFR)** parts 91, 121, 125, and 135 require the carriage of at least one pyrotechnic signaling device for each life raft for extended overwater flights.

4. DEFINITION. For the purpose of this advisory circular, reference to “U.S. Coast Guard approved,” in accordance with Title 46 of the Code of Federal Regulations (46 CFR) part 160, implies the minimum standards suggested by the FAA for pyrotechnic visual distress signaling devices. Reliance on U.S. Coast Guard expertise in the area of pyrotechnic signal device performance criteria is predicated on their historical involvement with the entire spectrum of search and rescue techniques, which they have originated and successfully implemented.

need to move to another location, some ways to transport an injured person that cannot walk would include creating a stretcher, dragging, or carrying. Stretchers can be made from the aircraft wreckage (*an aircraft seat could be used to carry one person*) or by using what nature has provided (*tree limbs with a blanket*). Dragging them, laying them on a piece of wreckage (i.e. wing) or putting them on a blanket or in a sleeping bag, may prove an effective means to get them where they need to go safely. Carrying someone should be your last choice as this will tend to fatigue you more quickly and is more likely to aggravate a neck or back injury. The fireman’s carry (*placing the person on your shoulder*) or pack-strap carry (*having the person stand and drape their arms over your shoulders so that you can grab them, lean forward, and carry them like a pack on your back*) are useful in moving someone that is injured.

Immobilize Fractures

Realize that fractures, sprains, strains, and dislocations have little in common medically, other than involving the skeleton and its connective structures. However, they have similar effects on you as a survivor. All can cause severe pain, swelling and lack of desire or the ability to use the affected part. Regardless of the ultimate diagnosis, these injuries can deprive you of part of your survival equipment. Even a sprained finger can be quite a loss when you are trying to light a fire under life-and-death circumstances.

Fortunately, the survival treatment for all four structural injuries is the same; there is no need to attempt an exact diagnosis. Leave that to the doctor when you get home. Do not try to “set” a fracture or “reduce” a dislocation. That’s the job for a professional. Just immobilize the injury, leaving it the way you found it and in a position of function, and you will reduce the pain and prevent aggravating the problem.

Hand, arm, and shoulder injuries can often be immobilized sufficiently with a simple sling. You can make one from your belt, lengths of rope, or a piece of clothing—anything that will form a loop around your neck to support the damaged arm. With a little patience you can even make a sling with one hand. One survivor even improvised slings for **two** broken arms. He used his teeth to tie the knots. Another improvised immobilization method for an arm or shoulder injury would be to place the hand of the injured arm or shoulder inside the front of a button-up shirt or zip-up jacket at chest level and bind the arm to the body.

Splints are effective for protecting structural injuries. You can fashion splints from small poles, tree limbs, cardboard or any rigid or semi-rigid object you can find. An injured leg may be temporarily splinted against an uninjured leg. Always pad the splint to prevent painful pressure or abrasions. Use cloth strips or tape; **never** use cord or twine as it may constrict circulation. Tie the splint in place with plenty of snug knots (*the rule of thumb is to always*

Shock may be the result of heavy bleeding, severe pain, burns, allergies, infection, or psychological factors such as the sight of an injury or illness to yourself or passengers. Any of these causes may be present in a survival situation. The result is the same regardless of the cause. If blood circulation to the brain is disrupted, rather predictable symptoms appear.

If you have ever experienced shock, look for those unforgettable light-headed, weak, half-sick, and unreal feelings to be present. If you have never felt shock or if you are watching for it in someone else, here are the signs you can expect to see:

1. The skin will feel cold and clammy.
2. Breathing rate will increase and may be quick and shallow or irregular and gasping.
3. Pulse will be weak and rapid.
4. Nausea or vomiting is likely.
5. There will be some mental confusion.

Regardless of the cause, you can use one standard treatment:

1. Drink plenty of fluids (*but do not try to give them to someone who is unconscious*)
2. Lie down, preferably elevate the feet about 12 inches, and rest until the symptoms pass (*for a head wound, do not elevate the feet or head as increasing pressure to the head may be dangerous*)
3. Stay warm (*comfortable*), put on extra clothes or get into a sleeping bag if it is cold (*do not do this in a hot environment as sweating will only lead you deeper into shock*)
4. **Keep busy**, but don't overexert yourself (*This will enhance your "Will to Survive" and gives increased self-confidence as it reduces the desire to give up due to productivity that is viewed as capability*)
5. If the person in shock is not you, provide reassurance and let them assist in the treatment of their wounds as much as possible (*if able*).

Avoid Further Injury

Don't move an injured person any more than is necessary as this may only serve to aggravate the injured area. If you must move the person, as in removing them from the aircraft, take care to keep the head, neck and back aligned as much as possible, especially if a spinal injury is suspected.

As was discussed in a previous section, it is usually a good idea to remain in the vicinity of the crash site and not travel. However, should you

5. TYPES OF VISUAL DISTRESS SIGNALS. There is a wide variety of signaling devices, and no single device is ideal under all conditions and for all purposes. The most popular signaling device for aviation use is the hand-held combination flare and smoke device. Pyrotechnics make excellent distress signals and are universally recognized as such. However, one of the drawbacks of these devices is that they can be used only once. Considerations may be given to carrying several types. For example, an aerial flare can be seen over a long distance on a clear night, but for closer work, a hand-held flare may be more useful.

a. **U.S. Coast Guard approved visual distress signaling devices** are divided into two general categories:

- (1) Daylight signaling devices.
- (2) Night signaling devices.

b. The following table lists the current U.S. Coast Guard approved devices. The device must have the 46 CFR part 160 series number referenced to be considered U.S. Coast Guard approved. Devices that conform to SOLAS have a much higher performance level. In addition SOLAS devices carry an additional U.S. Coast Guard approval number in the 160.121 series for hand flares, and the 160.136 series for parachute flares.

Number On Device	Device Description	Accepted For Use
160.021	Hand-held red flare distress signals	Day & Night
160.022	Floating orange smoke distress signals. (5 min)	Day Only
160.024 160.028	Pistol-projected parachute red flare distress signals. (These signals require use in combination with a suitable approved launching device.)	Day & Night
160.036	Self-contained rocket-propelled parachute red flare distress signals.	Day & Night
160.037	Hand-held orange smoke distress signals.	Day Only
160.057	Floating orange smoke distress signals. (15 min)	Day Only

Number On Device	Device Description	Accepted For Use
160.066	Red aerial pyrotechnic flare distress signals. (These devices may be either meteor or parachute type and may need an approved, suitable launching device.	Day & Night

Table 3-1. U.S. Coast Guard approval number in the 160.121 series for hand flares, and the 160.136 series for parachute flares.

6. **WHEN AND HOW TO USE.** Visual distress devices are part of your aircraft's safety equipment. Check to see they are on board before departure so they may serve their intended purpose to summon help should the need arise. Visual distress signals can only be effective when someone is in a position to see them. When employing pyrotechnic devices, do so only when you see or hear a boat or aircraft, or you are reasonably sure that someone is in the proximity to see your signal and take action. Good judgment is an essential part of the successful use of visual distress signals.

a. **Red Hand-held flares** are most effective at night or in restricted visibility, such as fog or haze, but may be used any time. Hand-held pyrotechnic devices, such as flares and smoke signals, may expel ash and slag as they burn. Even though these particles cool quickly, they can cause painful burns or ignite materials that burn easily. The flare itself is very hot and can start a fire if it is dropped. Therefore, when using these devices, they should be held in such a way that hot slag cannot drip on a hand or arm, or flammable materials.

b. **Hand-held and floating orange smoke signaling devices** are good day signals, especially on clear days. Both signals are most effective with light or moderate wind. Higher wind tends to keep the smoke close to the water, which disperses it, making it hard to see.

c. **Red parachute flares**, either pistol launched or hand-held rocket propelled, are good distress signals for both day and night. These devices provide altitude, slow descent, and brilliant intensity. Their slow descent, however, makes them drift with the wind, which can lead a would-be rescuer away from the rescue site.

d. **Pistol-launched or self-contained rocket-propelled red meteors** can be used by day, but are most effective at night. Because of their rapid descent, they are less affected by wind than the slower descending signals. The burn time is also shorter and not as readily observed as the slower descending signals. Whenever a pistol or hand-held rocket-propelled distress signal is used, the wind must always be taken into account.

bright red, pulsing or spurting blood flow from a wound. In contrast, venous bleeding appears dark red and has a steady flow rate.



Figure 12-23

Whichever type of bleeding you encounter, stopping the flow, even if it is severe, can usually be accomplished by following these steps, in order, until the goal is achieved:



Figure 12-24

1. Apply direct pressure to the wound using a clean dressing (figure 23), if available (*Do Not remove this once in place*) and tie it in place using a square knot and placing the knot directly over the wound site (*this will continue to provide direct pressure*) (figure 24)



Figure 12-25

2. Elevate the wound area above the level of the heart (*Blood doesn't flow uphill well*) (figure 25)

3. Use pressure points to control flow to the area (*These are areas where an artery runs near a bone and pressing the artery against the bone acts like a valve*). (figures 26 & 27)



Figure 12-26 and 12-27

Rarely, if ever, will a tourniquet be needed to control bleeding under normal circumstances. But then a survival scenario is not a "normality" and your "Will to Survive" depends on you doing what must be done to survive the ordeal. As a last ditch effort to control bleeding a tourniquet may need to be applied. It is important to remember that the area below the tourniquet, unless blood flow is restored in a reasonable amount of time, will most likely be lost (*as in amputated*). Some "rules of thumb" on their application include:

1. Use a length of material at least 1" wide and sufficiently long enough to encircle the limb
2. Place the tourniquet as close to the wound site as possible (*Give up as little of the extremity as possible*)
3. Encircle the limb with the tourniquet and tie an overhand knot
4. Place a sturdy object (*i.e. screwdriver*) on top of the knot that you just tied
5. Tie an overhand knot over the sturdy object you selected in the last step
6. Tighten (*twist*) the object you have tied in place **until the bleeding is controlled**
7. Secure the object in place
8. **DO NOT** remove the tourniquet for any reason
9. Note (*write down*) the time that the tourniquet was applied (*This may help medical personnel, upon rescue, to decide if the limb is salvageable*).

Treat For Shock

Note: These steps will work for adults only (steps for children and infants are significantly different!)

1. Placing them on their back
2. Open the airway by tilting the head back (as discussed earlier)
3. Assess if the person is breathing (*look, listen & feel for about 5 seconds*)
4. Give 2 breaths (*if this does not work, see “Free the Airway” section*)
5. Feel for a pulse (*about 5-10 seconds*)
 - Place 2 fingers at the Adam’s Apple (center of the throat) and slide toward you into the crease in the side of the neck
6. If pulse is not present
 - a. Position yourself, kneeling, between the individual’s hip and shoulder
 - b. Using the middle finger of your hand closest to their feet trace the curve of their lowest rib to where it meets the breastbone. (**figure 19**)
 - c. Lay the index finger of that hand along side the middle finger
 - d. Place the heel of the other hand above the index finger and directly on the breastbone
 - e. Place the heel of the hand closest to their feet directly on top of the hand already on their chest and interlace the fingers of the two hands to take them off the victim’s chest
 - f. Position your shoulders directly over your hands and lock your elbows (**figure 20**)
 - g. Compress the chest 2 inches (*Do this 15 times*)
 - h. Move to the head, open the airway and give 2 breaths (**figure 21**)

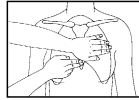

Figure 12-19



Figure 12-20



Figure 12-21



Figure 12-22

Note: Steps a) through h) should take about 15 seconds to perform

- j. Repeat steps a) through h)
- k. Recheck pulse and breathing at the end of one minute (4 cycles) and every few minutes afterwards. (**figure 22**)

Stop Bleeding

We depend on an adequate and uninterrupted supply of blood. Should this supply be cut-off, death will occur. There are two types of bleeding that you may encounter; arterial and venous. Arterial bleeding is characterized by

The idea of any signal is to attract attention to the survivor. Wind can carry an aerial flare a considerable distance and should be taken into consideration when aiming. With no wind the flare can be fired straight up. If the wind is light to moderate the flare should be launched slightly into the wind while increasing the angle as the wind speed increases.

7. HANDLING AND STORAGE.

a. **If young children are carried on board** your aircraft, careful stowage of visual distress signals becomes especially important. Projected devices, such as pistol-launched and hand-held parachute flares and meteors, have many of the characteristics of a firearm and should be handled with the same caution.

b. **Pyrotechnic devices** should be stored in a cool, dry location and be readily accessible in case of an emergency. Care should be taken to prevent puncturing or damaging of the device’s covering. It is recommended that pyrotechnic devices be stored in a watertight container and prominently marked “DISTRESS SIGNALS.”

c. **U.S. Coast Guard approved pyrotechnic devices** carry a service life expiration date. Currently, this date may not exceed 42 months from the date of manufacture. The U.S. Coast Guard indicates that it is acceptable to keep recently expired signals as extra equipment, although they gradually lose their effectiveness with age.

INFORMATION. For additional information regarding pyrotechnic devices, consult the U.S. Coast Guard web page at www.uscg.mil/hq/g-m/mse4/vds.htm.

End of AC-91-58A

ELECTRONICS

An electronic signaling device may be the difference between being a survivor for a few hours or a few days. Knowledge of the devices, and the proper use, could be a large factor in determining the length of time for your rescue. Common electronic devices can include:

Radio’s	Strobes
ELT’s	Lasers
PLB’s	Flashlight
Global Positioning System (GPS)	Cell or Satellite phone

The **aircraft radio** is your first source of electronic signaling. According to the Airman Information Manual (AIM), the initial communication, and any subsequent transmissions by an aircraft in distress should begin with the signal MAYDAY, preferably repeated three times. The signal PAN-PAN should be used in the same manner for an urgency condition.

Typically, the station addressed will be the air traffic facility or other agency providing air traffic services. If unable to immediately establish communications with an air traffic facility you should squawk MODE A/3, Code 7700/Emergency and MODE C.

You should transmit a distress message consisting of as many as necessary of the following elements, preferably in the order listed:

- If distress, MAYDAY, MAYDAY, MAYDAY; if urgency, PAN-PAN, PAN-PAN, PAN-PAN.
- Name of station addressed
- Aircraft identification and type.
- Nature of distress or urgency.
- Weather.
- Pilots intentions and request.
- Present position, and heading, or if lost, last known position, time, and heading since that position.
- Altitude or flight level.
- Fuel remaining in hours and minutes.
- Number of people on board.
- Any other useful information.

If time and circumstances permit you should also provide:

- ELT status (*Electronic Locator Transmitter*)
- Visible landmarks
- Aircraft color
- Emergency equipment on board.

The aircraft radio may still function even after the crash. If you are able to get to it, try to see if it can be used. But, make sure that you give enough time for the aircraft to cool and eliminate the chance of fire.

A **survival radio** is another option you have. A survival radio should function as both an ELT and a two-way radio. Refer to the Operating Manual to turn the device "ON". There are a few considerations before using these devices:

- ELTs (*Aircraft or Raft ELT overrides the voice mode*)
- Line of Sight (*Signal can be blocked by obstacles*)

- Straddle their thighs
- Place the palm of one hand on the individuals abdomen, at about the navel, with the second-hand on and interlaced with the first (**figure 10**)
- Give up to 5 inward and upward abdominal thrusts (**figure 11**)
- Look into their mouth, lift the jaw and tongue, and remove, with a sweeping motion, any foreign object you see (**figure 12**)
- Attempt to give 2 breaths (**figure 13**)
- Continue this process until the breaths go in.



Figure 12-10 & 11



Figure 12-12



Figure 12-13

Initiate Breathing

If an individual is not breathing, you must start this process by:

Note: These steps will work for adults or children (*steps for infants are significantly different!*)

- Placing them on their back
- Open the airway by tilting the head back (as discussed earlier) (**figure 14**)
- Assess if the person is breathing (*look, listen & feel for about 5 seconds*)
- Attempting to give 2 breaths (*if this does not work, see "Free the Airway" section*) (**figure 15**)
- Feel for a pulse (*about 5-10 seconds*) (**figure 16**)
Place 2 fingers at the Adam's Apple (center of throat) and slide toward you into the crease in the side of the neck.
- If pulse is present, give one breath about every 5 seconds (*12 times/minute*) until they breath on their own. **For children:** Give one breath every 3 seconds (*20 times/minute*) (**figure 17**)
- Check for pulse and breathing about every minute. (**figure 18**)



Figure 12-14 and 12-15

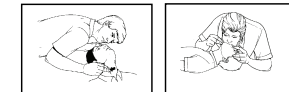

Figure 12-16 and 12-17



Figure 12-18

Restore Circulation

If you should find that a person is not breathing and has no pulse, perform the following steps:

- Stop Bleeding
- Treat for Shock
- Avoid Further Injury
- Immobilize Fractures
- Dress Wounds

Free the Airway

For any number of reasons a person's airway may become compromised. If they are conscious and choking, perform abdominal thrusts by:

Note: These steps will work for adults or children (*steps for infants are significantly different!*)

1. Standing behind the individual
2. Reaching around them (under their arms)
3. Making a fist and placing it at about the navel (belly button) (**figure 1**)
4. Grasping the fist and pulling inwards and upwards until the object is dislodged or they become unconscious (*Don't panic if this happens!*) (**figure 2**)



Figure 12-1



Figure 12-2

If they are unconscious, or become that way:

1. Establish unresponsiveness (*tap & shout*) (**figure 3**)
2. Assess if the person is breathing (*look, listen & feel for about 5 seconds*) (**figure 4**)
3. Place the person on their back (**figure 5**)
4. Open the airway by tilting the head back (*Head-tilt, Chin-lift method*) (**figure 6**)
 - One hand on forehead
 - Two fingers of other hand under the chin
5. Assess if the person is breathing (*look, listen & feel for about 5 seconds*) (**figure 7**)
6. If breathing is absent attempt to give 2 slow breaths (**figure 8**)



Figure 12-3 and 12-4

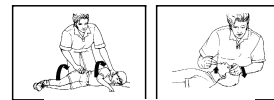

Figure 12-5 and 12-6

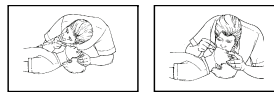

Figure 12-7 and 12-8

- If breaths don't go in the first time, try repositioning the head, then give 2 more slow breaths (**figure 9**)
- If they still do not go in, you have an obstructed AIRWAY AND NEED TO:



Figure 12-9

- Cone of Silence (*A weak signal from top of antenna*)
- When using the survival radio it is suggested to leave the 406 MHz signal engaged at all times. Use the Voice mode to transmit a Mayday every 15 minutes, unless an aircraft can be heard or seen, then continuously.

Remember, when using this type of device, turn off the aircraft and raft ELT. If an aircraft is approaching, and you are attempting to communicate with it, don't point the antenna directly at the aircraft, as this will put the aircraft in the cone of silence. Radio's offer up to three frequencies: 121.5 MHz (*the international distress frequency*) and 243.0 MHz (*the military emergency frequency*) and the newer 406 MHz. Although satellite coverage of 121.5/243 MHz will cease in 2009, aircraft within a 12 mile radius may still be able to hear your signal if they are monitoring these radio frequencies. At the very least, SAR crews are likely to be monitoring these frequencies in a known search area.

Emergency Locator Transmitter - ELT

There are three types of beacons used to transmit distress signals, Emergency Position Indicating Radio Beacon or EPIRBs (maritime use), Emergency Locator Transmitter or ELTs (aviation use), and Personal Locator Beacons or PLBs. The first of these to be developed was the ELT.

ELT's were originally designed to broadcast a signal on the 121.5 and 243 MHz frequency. Originally designed to alert aircraft flying overhead, this greatly reduced the communication range and the ability to notify SAR authorities. The Cospas-Sarsat (satellite) system was developed to provide a better receiving source for these signals. Location data was also able to be obtained with the new satellite system.

Nearly all aircraft operators are required to carry an ELT. Presently the operator can choose between the older model ELT that transmits on 121.5 or the newer 406 MHz.

As of February 2009 the Cospas-Sarsat system will terminate satellite processing of distress signals from an 121.5 and 243 MHz, older model ELT. The National Oceanic and Atmospheric Administration (NOAA) states that the decision to stop satellite processing of 121.5 and 243 MHz signals is due to problems in this frequency band which inundate search and rescue authorities with poor accuracy and numerous false alerts (99% according to NOAA), adversely impacting the effectiveness of lifesaving services. NOAA, along with the U.S. Coast Guard, U.S. Air Force, and NASA (the four Federal Agencies who manage, operate, and use the SARSAT system) are strongly advising users of 121.5/243 MHz to make the switch to 406 MHz.

According to studies, 134 extra lives and millions of dollars in SAR resources could be saved per year by replacing the old 121.5 MHz units with the newer 406 MHz. The only problem is that 406 MHz ELTs currently cost about \$1,500 or less and 121.5 MHz ELTs cost around \$500. It's easy to see one reason for the cost differential when you look at the numbers. However, no one can argue the importance of 406 MHz ELTs and the significant advantages they hold.

The following are a few comparisons of the 406 MHz and 121.5 MHz distress beacon provided by the United States Coast Guard.

	406 MHz Beacons	121.5 MHz Beacons
Coverage:	Global	Ground station dependent; ground stations have an effective radius of about 1800 nm. Current coverage is about one-third of the world.
Reliability; False Alerts/ False Alarms:	<p>All alerts come from beacons. Satellite beacon transmissions are digital, coded signals. Satellites process only coded data, other signals are rejected.</p> <p>About 1 in 10 alerts are actual distress.</p> <p>Beacon-unique coding/ registration allow rapid incident corroboration. Registration mandatory 9/13/94. 90% beacons are registered. About 80% of false alarms are resolved by a phone or radio call to registration POCs prior to launching SAR assets.</p>	<p>Only about 1 in 5 alerts come from beacons. Satellites cannot discern beacon signals from many non-beacon sources. Beacons transmit anonymously.</p> <p>Fewer than 3 in 1000 alerts and 3 in 100 composite alerts are actual distress.</p> <p>Since 121.5 MHz beacons transmit anonymously, the only way to ascertain the situation is to dispatch resources to investigate -- a costly disadvantage.</p>
Alerting:	<p>First alert confidence sufficient to warrant launch of SAR assets. Earlier launches put assets on scene earlier -- Average 2.5 hrs saved in maritime, 6 hrs in inland.</p> <p>Average initial detection/alerting by orbiting satellites is about 45 minutes -- worst case 60 minutes.</p> <p>Average subsequent satellite passes every 60 minutes.</p>	<p>High false alarm rate makes first-alert launch unfeasible. Absent independent distress corroboration, RCCs must wait for additional alert information.</p> <p>Same as 406 MHz.</p> <p>Same as 406 MHz.</p> <p>Alerts are anonymous. 121.5 MHz technology not capable of transmitting data.</p>

SURVIVAL FIRST AID/SELF AID

Nothing reduces your chances of survival as much as an injury. The very nature of aviation can produce situations requiring that you be able to take care of yourself and your passengers in a medical emergency. First aid is geared to relatively short-term treatment intended to stabilize an injured person until professional help can be obtained.

Under survival conditions, you don't know how long it will be until professional help will arrive and you may have to use or even misuse an injured body part for higher priority problems---like shelter building or signaling. Remember, in a survival situation treating injuries and illness must be one of your highest priorities as these can reduce your "Will to Survive" and ability to overcome physical and mental obstacles. However, you cannot make treating the injury or illness your sole function. You must do everything possible to minimize its impact on your survival. In this section, we will cover some of the most common survival injuries and the current treatment methods.

The pain associated with many injuries and illness may be serious enough under survival conditions to warrant attention as a separate problem. First, understand that pain is a signal and not dangerous in itself. It reminds you to rest that part of the body. Under normal conditions, this is good; but when your life depends upon your ability to deal with survival problems, you may have to ignore the warning. Successful survival cases are full of instances where people did just that. Individual sensitivity and reaction to pain varies tremendously, but keeping busy and concentrating on the business of being rescued can reduce the impact of pain. Try to look at your pain as a temporary discomfort that can be tolerated. Naturally, you want to avoid aggravating the pain or injury that is causing it, but remember to keep your mind on the goal. You want to get home, so work on that!

It is wise to attend annual first aid and CPR training, of which this portion of the manual is in no way a substitution, to maintain proficiency in those areas. CPR and First Aid procedures and illustrations listed in this section, in part, come from the American Red Cross Community First Aid & Safety training manual, Mosby Lifeline, Mosby-Year Book, Inc., 1993. It will be important that you treat the injuries or illness that you encounter during a survival situation in a logical manner, caring for life-threatening situations first. To this end, we will use the words "First Aid" as an acronym to give a basic guideline of steps to follow:

- Free the Airway
- Initiate Breathing
- Restore Circulation

BUILDING A FIRE
Chapter Quiz

1. Three basic elements of a fire are:
(Circle the best answer)

- a. Tinder, kindling and fuels
- b. Oxygen, heat and fuel
- c. Pressure, density and temperature
- d. All of the above

2. A fire can provide a survivor with a source of:
(Circle the best answer)

- a. Protection
- b. Light
- c. Warmth
- d. Companionship
- e. All of the above

3. When starting a fire you must gather three piles of material consisting
of _____, _____, _____.

4. You should avoid building a fire in:
(Circle the best answer)

- a. In a dry resinous (pine) forest
- b. Under snow covered trees
- c. Directly on snow
- d. All of the above

Alerting:	Vessel/aircraft ID, point of contact information provided with alerts allows rapid corroboration or stand-down. Allows false alarm follow-up to continuously improve system integrity/reliability. Near instantaneous detection by geostationary satellites. System provides worldwide coverage.	No capability.
Position Information:	1-3 nm (2-5 km) accuracy on average. Position calculated by Doppler shift analysis. 100 yard accuracy with GPS-equipped beacon. GPS position processed with initial alert. System infrastructure now available.	12-16 nm (15-20 km) accuracy on average. Position calculated by Doppler shift analysis. No capability
Locating the Target:	Superior alert (non-GPS) position accuracy limits initial search area to about 12.5 sq nm (20 sq km). GPS-equipped beacons reduce search area to a negligible area.	Initial position uncertainty results in 450 sq nm (700 sq km) search area on average. No GPS capability. 121.5 MHz homing signal facilitates target location by radio direction finder equipped search units. (12 mile range)
Power Output:	5.0 Watts	0.1 Watt

3-2 U.S. Coast Guard comparison located at: <http://www.uscg.mil/hq/g-o/g-opr/emergencybeacons/epirbcomp.htm>

ELT's are designed to either activate automatically, upon impact, or manually and are generally located in at least on of the following three areas:

- Aircraft
- Raft
- Kits

The following information was excerpted from an original article entitled "**Cospas-Sarsat: Saving Lives for 20 Years**". It was authored by NOAA and reprinted with permission of FAA Aviation News

How it Works

The Cospas-Sarsat system consists of emergency radio beacons carried on aircraft and ships, equipment on satellites, ground receiving stations (also called Local User Terminals), Mission Control Centers, and Rescue Coordination Centers. When an aircraft, ship, or person is in distress, an emergency beacon is activated. These beacons transmit distress signals to the satellites either on the 121.5, 243, or 406 MHz frequencies. In the case of aircraft, the beacons are well known by pilots as Emergency Locator Transmitters, or ELT. Ground stations track satellites in the Cospas-Sarsat constellation and process the distress signals. The processed information is then forwarded to a Mission Control Center where it's combined with other information and passed to search and rescue authorities.

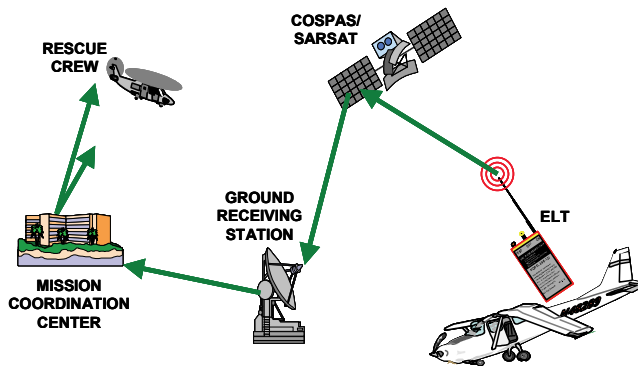

3-3 FLOW OF INFORMATION FROM ELT

The ground station receives the emergency signal and calculates the location of the signal by one of two methods. In the case of 121.5 and 406 MHz signals detected by polar orbiting satellites, the position of the distress beacon is computed using Doppler technology (the relative motion between the satellite and the emergency beacon). In the case of 406 MHz signals detected by geostationary satellites, only those beacons equipped with GPS capabilities can be accurately located. This position can then be transmitted as part of the distress signal to a mission control center. In the United States, NOAA operates 14 Local User Terminals (LUT) in seven locations. There are two LUT in each of the following locations: Suitland, MD; Houston, TX; Vandenberg AFB, CA; Fairbanks, AK; Wahiawa, HI; San Juan, Puerto Rico; and Andersen AFB, Guam. There are currently 39 LUT in operation worldwide with several more being built each year.

The U.S. Mission Control Center (USMCC) in Suitland, MD, obtains the location information from the ground receiving stations. The USMCC combines this information with other satellite receptions (from other ground stations and MCC), further refines the location and generates an alert message.

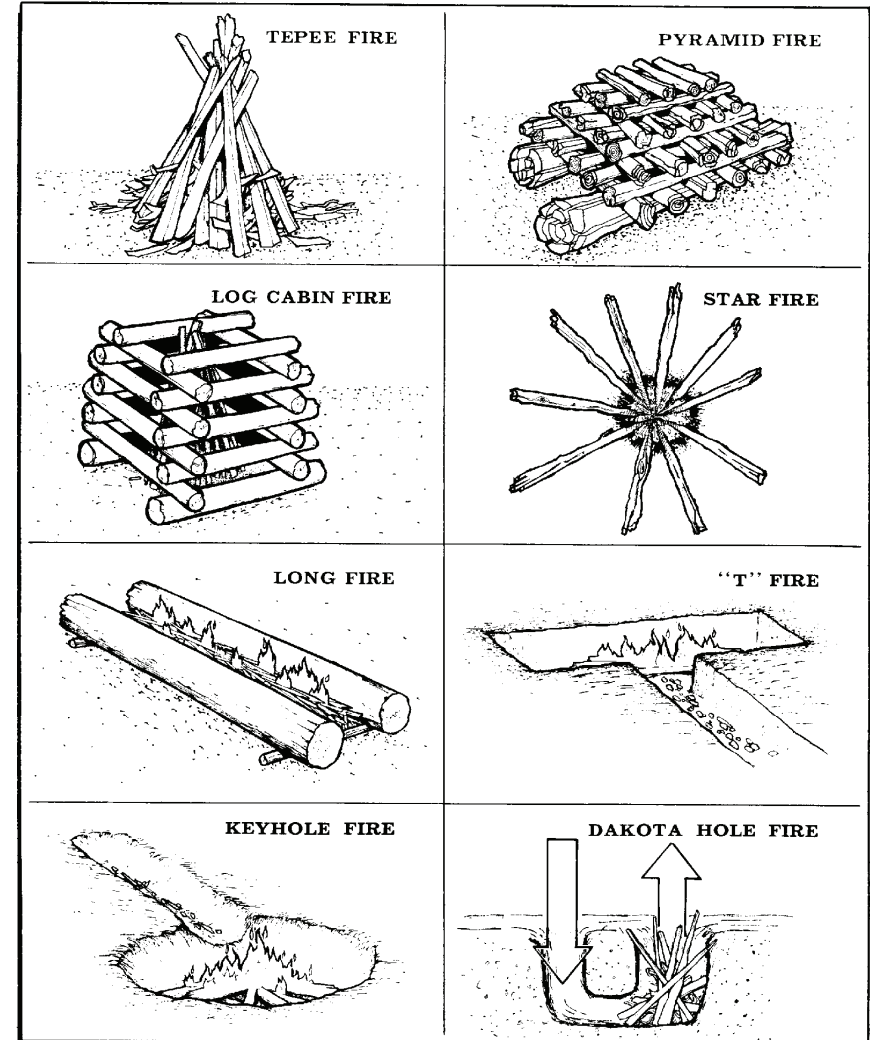

11-3 FIRE LAYS USAF Regulation 64-4.

Start tinder burning and provide a steady draft (*lightly blow on it*) until burning.

Remember to build a fire big enough to suit your needs. A fire too big will be hard to maintain. There are two types of fires:

"Wise man's Fire" - Just big enough to keep you warm.

"Fool's Fire" - *Too big*. You keep warm by running to get more wood.

There are several ways to arrange wood so that it burns more efficiently. Choose one that best suits your needs. Always keep more tinder, kindling, and fuels than you expect to use. Never let your wood fuel run too low. The time to get more is not when you run out.

Helpful Hints:

- To reflect the heat, erect a solar blanket near the fire (Place reflective side towards the fire), but not so near that it ignites.
- Several small fires heat more efficiently than one large fire (*Place them around you*).
- If you have no choice but to build your fire on the snow, find a platform (*Anything that is fireproof or slow burning*) to build it on. A crisscross of green logs will help keep the fire from sinking.

This alert is then transmitted to the appropriate Rescue Coordination Center based on the beacon's geographic location and/or identification. If the location of the beacon is in another country's service area, the alert is transmitted to that country's MCC. This is possible because all Cospas-Sarsat MCC are interconnected through nodal MCC that handle data distribution in a particular region of the world. Currently, there are 24 MCC worldwide (five of which are nodal MCC operated by the United States, France, Russia, Japan, and Australia). Although the operation is always manned, the vast majority of alert data distribution is handled automatically.

Once the Rescue Coordination Center is alerted, it begins the actual search and rescue operation. In the United States, these rescue centers are operated by the U.S. Coast Guard for incidents at sea and by the U.S. Air Force for incidents on land. In the case of NOAA-registered 406 MHz beacons, the RCC telephones the beacon's owner and/or emergency contact, and if it cannot determine that the signal is a false alarm, it dispatches search and rescue (SAR) teams to locate the aircraft or vessel in distress.

In the case of 121.5 MHz beacons, which cannot be registered with NOAA, each distress call, whether real or a false alarm, must be tracked to the source using direction-finding equipment. The manpower and cost of responding to false alarms are extremely high. To avoid false alerts, NOAA recommends that pilots be sure to use care when testing and maintaining their ELT and follow the manufacturer's recommendations carefully.

Search and rescue forces are sent out either by the U.S. Air Force, the U.S. Coast Guard or local SAR personnel depending on the origin of the emergency signal. SAR forces include fixed wing aircraft, helicopters, ships, boats, search parties, and sometimes commercial ships. The SAR forces find the people in distress and bring them to safety. To focus the SAR team's initial search, all 121.5 MHz and most 406 MHz beacons transmit a second "homing" frequency of 121.5 MHz. Armed with radio detection devices, the Coast Guard and other rescue authorities can track the homing frequency and quickly locate the emergency beacon.

A Cospas-Sarsat polar satellite will typically overfly a beacon within an hour and calculate a Doppler-determined location. This process can locate beacons within an accuracy of 5-12 miles for 121.5 MHz beacons and 1-3 miles for 406 MHz beacons. The 406 MHz beacons detected by geostationary satellites provide immediate alerts. However, they are not able to be located using the Doppler shift because these satellites have no relative motion between them and the emergency beacons. They can, however, be registered in NOAA's beacon database. Thus, if the 406 MHz beacon has been registered, the SAR team can begin its initial verification of the alert using the information contained in NOAA's beacon registration database.

Often this detective work yields a general location of the vessel or aircraft in distress and SAR assets can be readied or dispatched to that general area. Then, when a polar orbiting satellite flies over the beacon, its exact location can be calculated using the Doppler shift and the location forwarded to the SAR personnel who may already be en route.

Satellites

NOAA operates both polar-orbiting and geostationary environmental satellites that are used primarily for environmental applications. Each satellite also carries Search and Rescue Satellite-Aided Tracking (Sarsat) payloads that can detect and locate emergency beacons activated by people in distress

NOAA's Polar Orbiting Environmental Satellites circle the earth every 102 minutes at an altitude of about 850 km (526 miles). The Russian Cospas polar satellites circle the Earth every 105 minutes at an altitude of about 1,000 km (620 miles). Antennas aboard the satellites detect both 406 and 121.5 MHz emergency beacon signals and relay them to ground stations. Since the satellites overfly the poles on every orbit, coverage is best there and least at the equator. In the mid-latitudes, the average waiting time for a satellite pass is 30-45 minutes, with quicker passes near the poles.

NOAA's Geostationary Operational Environmental Satellites orbit at about 36,000 km (22,320 miles) above the Earth's equator. From this vantage point, GOES can see large portions of the Earth continuously. GOES satellites can detect only 406 MHz emergency beacons. The more advanced 406 MHz beacons often have GPS capacity, which can provide their position. GOES satellites relay 406 MHz signals to ground stations immediately after a beacon is activated.

As of July 2008 it has become mandatory on international GA flights to carry the newer 406 MHz beacon. Additionally, the COSPAS-SARSAT satellite system will discontinue satellite based monitoring of the 121.5/243 MHz frequencies as of February 1, 2009. The 121.5/243 MHz ELT's will not be illegal from the FAA's perspective, it highly encourages all aircraft owners and operators to upgrade to newer 406 MHz equipment. The 121.5 MHz

The 406 MHz offers the user many more benefits than does the 121.5 MHz. After satellites stop monitoring the 121.5/243 MHz signal in 2009, transmissions from these devices will only be detected by ground-based receivers such as local airport facilities and air traffic control facilities, or by overflying aircraft. Therefore, use of the 121.5/243 MHz ELT's will result in limited assistance, especially in remote locations.

Personal Locator Beacon

<i>Kindling</i>	<i>Fuels</i>
Finely split wood	Dead wood
Fuzz stick	Dry peat
Dry dead branches	Coal
Twigs	Dried dung
	Animal fat
	Bundles of grass

11-1 FIRE STARTING MATERIALS

Arrange tinder, kindling, and small fuel into a teepee stack. If the fuel, wood, is too large, it may smother the fire. Start out small, and then progress up. Do not pack the material so dense that there is little to no air available to fuel the fire once it is lit. More than likely you will have to improvise some sort of wind break for your fire. This can be anything from your raft to pieces of the fuselage.

There are many devices designed to be an ignition source for your fire. Just because you are in a survival situation doesn't mean you have to give-up all of your modern day conveniences. This is especially true when starting your fire. When choosing the ignition source to carry, think ease. You should have a plentiful source of waterproof matches available as well as butane lighters. If you can't find waterproof matches available you can dip the end of your matches in hot wax. Ensure that your lighters are fueled periodically so that when the time comes to use it, it actually works.

Another source of ignition is referred to as a metal match. There are actually many variations of the metal match to choose from, but the most effective combine flint and magnesium. All metal matches consist of flint which when scraped by a sharp object, such as a knife, will create a spark. Some metal matches combine magnesium, which you shave into small piles to assist the flint in igniting your fuel source. The magnesium burns very hot and very quick. Make sure that you pile the shavings on your fuel source prior to ignition.



11-2 METAL MATCH

<i>Matches</i>	<i>Candle</i>	<i>Battery and steel wool</i>
<i>Lighter</i>	<i>Fire Paste</i>	<i>Magnifying glass</i>
<i>Flint or Magnesium Match</i>	<i>Night end of MK-13 or similar flares</i>	<i>Campfire starter</i>

FIRE BUILDING

A fire can be a survivor's best friend. A fire will provide light, warmth, a signal, purify your water, provide protection, and act as a companion. Also, when you build a fire it will give you a sense of accomplishment and confidence in your survival skills. Skill in fire craft is achieved through practice, not through reading a book.

In order for a fire to exist, three basic elements are required. This is known as the fire triangle and it is composed of:

- Oxygen (*Air*)
- Fuel (*Anything that will burn*)
- Heat (*Ignition source*)

If one of these basic elements is missing, the fire will not burn. The most common mistake in fire building is the improper placement of the wood. It needs to be placed so that plenty of oxygen can feed the fire.

Before building a fire you need to find a suitable location. Never build a fire:

- In a dry resinous (*pine*) forest
- Under snow covered trees
- Directly on snow
- On or near wet rocks (*chance of explosion*)

A good plan would be to dig down to mineral soil (*Absent of roots and debris*) and build your fire there.

You will find a list of items you should gather on the following page. Ideally, you would want to gather three large piles of each.

Tinder

Dry grass	Cotton or scraped cloth	Powder wood
Candle	Lint off clothing	Steel wool
Reddish pine needles	Shaved stick	Hair
Paper	Inner bark of a cedar	Dry moss
Oil soaked cloth		Fine dried wood shavings

Personal Locator Beacons or PLB's operate similar to the ELT's already discussed. They are designed to be carried on an individual rather than attached to the aircraft. A PLB can only be manually activated and transmit on 406 MHZ. PLB's also have a low powered homing beacon that transmits 121.5 MHZ. The homing beacon allows rescue crews to home on a device after the 406 MHZ transmission has gotten them into the general area. Devices with the GPS option can further reduce the search area to as little as 100 meters. PLB's and ELT's can be registered online through the NOAA website at: <http://www.beaconregistration.noaa.gov>.

A newer product gaining in popularity as a signal device are **Lasers Flares**. Laser Flares look similar in body to laser pointers but are designed to be used as signaling devices. Some hand-held devices can be visible for up to 20 miles away under optimal conditions. Make sure they are US Food and Drug Administration approved Class IIIA Laser products. These are safe to look at and would pose no danger if aimed at an overhead aircraft.

If you can operate a flashlight you should have no problem using a laser flare. The flare will emit a flat line and the further away from the target, the longer or higher the line. When using the device as a signal flare remember to aim the laser line vertically at your target and scan slowly from left to right.

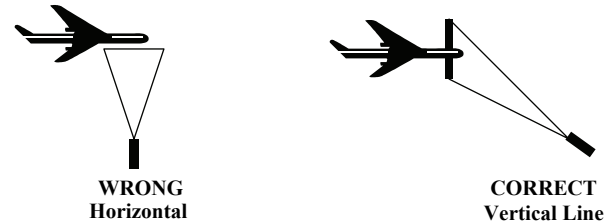

A **hand-held Global Positioning System (GPS)** used in conjunction with a 2-way radio is a very effective signaling device. Some units are the size of a small, flat calculator. Most GPS systems contain a 12 parallel channel receiver. The system can provide the user with his/her longitude and latitude with an accuracy of +/- 3 meters. Some units have map software which can provide additional information about the area in which you may have found yourself. Information concerning the location of food, lodging, service stations, and more, can be found on some software, usually at an additional cost. Additionally, some 406 MHz devices offer embedded GPS chips, which, when activated will send the survivors coordinates directly to the rescuers using the satellite.

A **strobe light** is an electronic device that emits a continuous flashing light. If used in a continuous mode, it should continually flash for up to nine hours. It will be a judgment call to either let it flash continuously or in cycles.

hours. It will be a judgment call to either let it flash continuously or in cycles. A consideration would be that an aircraft might be able to see the light before you hear the aircraft approaching. But, again, this is going to be a judgment call. Carrying an extra battery will be of great benefit.

A **cellular phone** is another option as an electronic signaling device. As long as your phone can pick up a signal you will be able to dial 9-1-1. Unfortunately this rules out many remote areas where your phone would be of great benefit. Satellite phones are an option for use in remote areas. You should always ensure that the phone battery is fully charged before all flights. This will help provide you with the optimum time possible for signaling.

Satellite phones, or Sat phones, are becoming more common place as price become more reasonable and availability increases. For those who fly internationally, a Sat phone is highly recommended.

When flying over water you should pack all of your electronic devices in a waterproof pouch or container.

OTHER SIGNALING DEVICES

- **Police whistle** (*Audio signal*) – great for alerting ground searchers as well as survivors that may have strayed from camp.
- **Flashlight** (*A good night signal*)
- **Chemlight** (*A good night signal*) Usually last 12 hours. Works well on a string while twirling.
- **Solar blanket** (*Reflector on one side and orange on the other side*)
- **Water activated lights** (*Found on rafts and LPUs*)
- **Streamers** (*Land and Water signal*) – works well in replacing the old sea dye markers.

The **signal mirror** is considered by many to be a most effective visual signaling device. Flashes from signal mirrors have been spotted from over 25 miles. A signal mirror works best on clear, sunny days, but is still effective even on cloudy/overcast days. Even if you don't hear an aircraft approaching, you may still want to make sweeping motions towards the horizon. It can even be tried on a string and suspended (i.e. from a tree branch) for hands free operation.

IMPROVISED SIGNALS

When improvising, you are taking an item used for one purpose, and adapting it to your needs. An improvised signal can be made or taken right out of the kit. Since resources may be limited, the kits are probably the best source.

PICK-UP DEVICES

Chapter Quiz

1. Where is the one place you should never stand when dealing with a pick-up device?

(Circle the best answer)

- Directly in front of
- Directly underneath
- Directly behind
- It doesn't matter

2. At what point should you grab the pick-up device?

(Circle the best answer)

- At any time the device is within reach
- Only after the device has come into contact with the water or ground
- Only when given the go ahead from the PIC
- It doesn't matter when you touch the device as long as you are able to swim to it.

3. Which pick-up device is designed to extract a survivor from thick foliage, such as jungle or forest overgrowth?

(Circle the best answer)

- Horse Collar
- Rescue Basket
- Forest Penetrator
- There is no such device

PREPARE FOR ASCENT - When the above is accomplished and you are ready, give a thumbs-up. At this time, the helicopter will lift you up. It is very important not to cross or lock your legs under the device. As the device ascends, allow your legs to hang loose until off the ground. In the highly unlikely event of cable breakage, you will need your legs below you, not locked underneath.

Directions for using the Forrest Penetrator pick-up device.

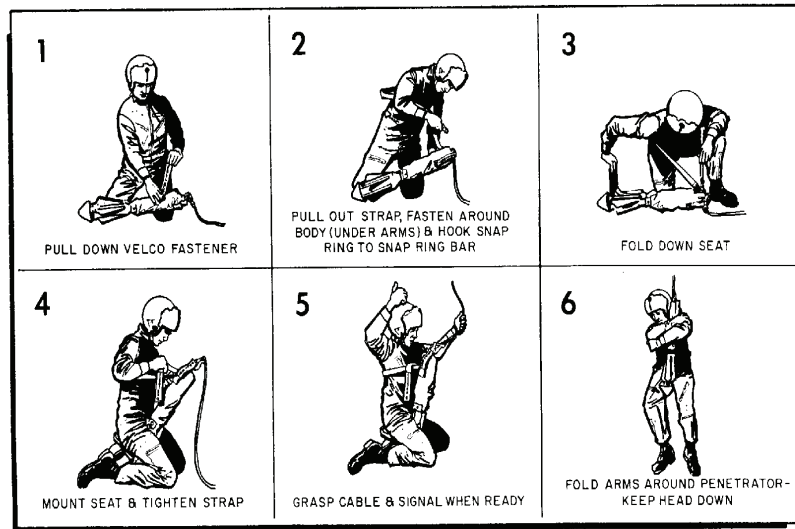

10-5 FOREST PENETRATOR. Illustration taken from AF Regulation 64-4.

RESCUE BASKET or STOKES LITTER - In the event of rescue involving untrained civilians at sea, a Rescue Basket or will be used. The procedure for safe use is simple. The survivor climbs-in, sits down, and is then hoisted out of the sea. The Rescue Basket is standard equipment aboard U.S. Coast Guard rescue helicopters.



10-6 RESCUE BASKET.
www.lifesavingsystems.com

When using **smoke and fire** as a signal, you must consider the type of environment you are in. When dealing with fire as a signal, it is apparent that it must be out in the open. Three fires in the shape of a triangle are recognized internationally as a sign of distress. However, any fire out in the open will be effective.

When using smoke, your primary consideration is to contrast smoke with the environment. In light or snow covered environments, you should use black smoke. In a dark or dense foliage areas, use white smoke. To produce a black-type smoke you should burn:

- Any petroleum product (*JP-4, hydraulic fluid, oil*)
- Any rubber or plastic based items (*tires*)
- Coniferous trees (*evergreens*)

NOTE: When burning any rubber or petroleum products, keep out of the smoke. It may contain toxic compounds.

To produce a white smoke, try burning the following:

- Green wood
- Green or dry leaves
- Moss
- Peat
- Ferns

The effectiveness of your smoke will generally depend on how high the smoke can rise; the hotter the fire, the higher the smoke will rise. To further enhance white smoke, you can activate the orange smoke flare and allow it to mix with the white smoke.

Another potential signal could be designed with the of the aircraft battery, using salvageable aircraft lights. However, this is not highly recommended due to the fire and chemical hazards of the battery.

It is possible to communicate a specific message to an aircraft-flying overhead without having a 2-way radio. This could involve any fabric, an emergency blanket, rocks, branches or anything else that could be manipulated into various shapes. The shapes that you mold should be designed to a 6:1 ratio, preferably 18 feet high by 3 feet wide. Various signals that are recognized can be seen below.

I	A doctor is needed
II	Medicine is needed
X	Can NOT continue
F	Water and/or food is needed
K	Which direction do I go
↑	Am proceeding in direction of arrow
LL	Everything is O.K.
N	NO
Y	YES
⌋	Message not understood
□	Map and/or compass is needed

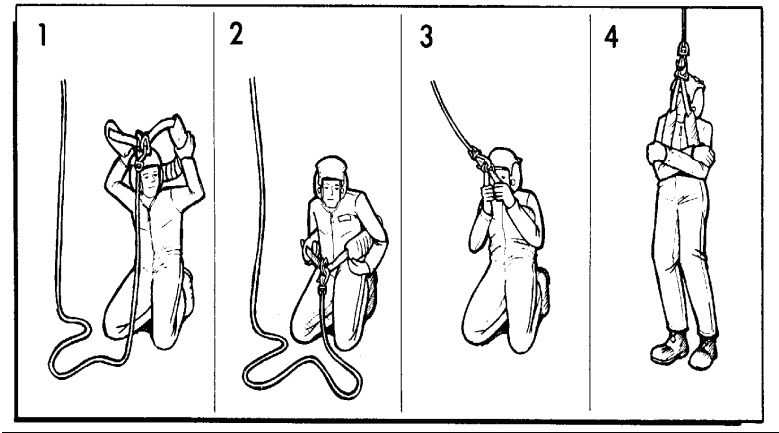

10-3 "Horse Collar". Illustration taken from AF Regulation 64-4.

FOREST PENETRATOR/RESCUE SEAT - These pick-up devices are designed to extract a survivor from thick foliage, such as jungle or forested overgrowth. However, these devices can also be used for maritime and land rescue operations. The device will hoist as many as two survivors at one time and has a seat and safety strap for each. This device is very simple and safe to use if the survivor follows these simple guidelines:



SET UP DEVICE - When the device has made contact with the ground or water, look for the seat and pull it down until it locks in place.

SECURE SAFETY STRAP - Once the seat has been locked in place, the safety strap should be pulled out and placed around the torso and then connected. Keep the strap under the armpits and the connector in front. Many times when this device is lowered, the safety strap will be out and fastened. If this is the case, then you must place the strap over the head and under the armpits, with the connector in front.

MOUNT DEVICE - Once the safety strap is on, the next action would be to mount the device. Put the seat of the device between the legs and raise the device, using the arms until the seat is snug against the crotch. This is a very important because if there is any space between the seat and the crotch, when the winch brings up the device, the seat could come abruptly in contact with the crotch area... OUCH! Next, hug the device and keep it close to your torso and keep your face to one side and down.

3-4 Standard ground-to-air signals. (Information taken from *DESERT SURVIVAL*. Dick and Sharon Nelson, 1977.)

When designing a signaling device the main purpose is to create a device that will gain attention. A good "rule-of-thumb" is to follow the CCLAS checklist. CCLAS is an acronym, which stands for condition, contrast, location, angularity, and size. Refer to chart 3-4 for more information

C	CONDITION	Check on the condition of your signal throughout your survival situation to make sure it is in good repair.
C	CONTRAST	The signal should stand out from its background.
L	LOCATION	Pick a spot that is high in altitude and high in visibility.
A	ANGULARITY	There should be an abundance of straight lines that set your signal apart from the rest of mother nature's curves.
S	SIZE	The proper ratio for signal is 6 to 1. The preferred size, if capable, is 18 by 3 feet wide.

3-5 CHECKLIST for improving the visibility of improvised signals

LET THE RESCUE PERSONNEL REMOVE DEVICE - Listen for instructions. Extraction from the water is as safe as it is on land. The guidelines will remain similar, with just a few more considerations:

The particular pick-up devices used to extract survivors is dependent on the type of helicopter used (*USAF, Navy, Army, USCG*).

QUICK STROP/RESCUE SLING - Sometimes mistaken for the "Horse Collar," the Quick Strop, a rescue sling, is essentially a padded loop. The sling is designed to fit under the arms and around the torso. An adjustable crotch strop prevents the survivor from slipping out of the device. The sling can be lowered as a closed-loop or opened. If it is lowered in the open configuration, then the survivor must:



Figure 10-2 Quick Strop
www.lifesavingsystems.com

DON SLING - Take the free end of the sling and roll it around the torso. Make sure that the sling fits underneath the arm pit area. Next, take the free end (*the end not connected to the cable*) and bring it to the front end, feed it through the restriction adapter, and connect it to the hook.

SECURE SAFETY STRAP - Remove the safety strap from its pocket on the back of the strop. Feed it between your legs and attach the clip to the notch on the friction adapter. Then tighten snugly & move the friction adapter towards your body. These straps will keep unconscious persons from slipping out (*though it is doubtful that they would slip out without the strap*).

PREPARE FOR ASCENT - Make sure that the cable and hook are in front of your face. Hug the rescue device and turn your head to one side to protect against facial injury.

If the sling is lowered in the closed configuration, you should:

DON SLING - Slip on the sling as if you were putting on a sweater. Push arms through the sling until the sling is below the arms and shoulders. Place the sling under your armpits.

SECURE SAFETY STRAP

GIVE A THUMBS-UP SIGNAL
PREPARE FOR ASCENT

Directions for using the Horse Collar pick-up device.

One thing is certain, just having signaling equipment available is not enough. Knowledge is the key to effective signaling. Knowledge is not only the signaling devices provided in your kits, but also in how to construct improvised signals. Practice is the best way to accomplish this, and can be accomplished through various means. You can attend survival courses, read, or practice locally. Most signaling devices have instructions posted on them. Read the instructions and familiarize yourself with them well before a survival situation occurs.

SIGNALING **Chapter Quiz**

1. The acronym CCLAS stands for C _____, C _____, L _____, A _____, S _____.
2. A signal that uses fire, smoke, or ballistics is a:
(Circle the best answer)
 - a. Pyrotechnic
 - b. Flare
 - c. Both a & b
 - d. None of the above
3. What should be the first signaling device used?
(Circle the best answer)
 - a. ELT
 - b. Survival radio
 - c. Aircraft radio
 - d. Signal mirror
4. Satellites will stop monitoring the 121.5 MHz frequency in what year?

5. In which three areas are ELT's commonly located: 1) _____, 2) _____, 3) _____

HOTLAND (DESERT) SURVIVAL

When you mention the word "hotland," what is the first thing that comes to mind? More than likely, your response centered on a desert. Though it is true that a desert is a "hotland," any region that you fly over has the potential for becoming a "hotland." Temperatures can rise quickly and without warning. For this chapter, we are going to concentrate on the desert, but the survival techniques to be described can be used in any "hotland."

Deserts cover nearly 20% of the world's landmass. They are found on most continents, and usually have inhabitants that live and thrive in this hostile environment. These inhabitants have learned to live with the desert, and not to fight it.

Deserts are found in three forms:

- **Rock Desert**
- **Sand Desert**
- **Salt Desert**

Each of these desert types is very different from the other. Sometimes a desert can start out as a sand desert, then turn into a mountainous rock desert. Although no two deserts are alike, they do share one common bond: They are hot! In 1972 - 1974 the National Park Service conducted surface temperature readings in Death Valley, California. These tests were conducted in July and August during the hottest part of the day. The average surface temperature was 182 degrees (F), but at times (1972) it hit as high as 201 degrees (F). It goes without saying temperatures as high as these would cause life threatening medical problems.

As the temperature outside increases, the inner core temperature of an unprotected person will also increase. To combat this heat build-up, the body produces sweat. Sweat is simply water, taken from the body's internal supply, and sent to the surface of the skin to promote evaporation. As the water evaporates, the skin and blood will cool. This system works very efficiently, as long as there is a sufficient water supply in the body. The average person loses 2 - 4 quarts of water through everyday activity. Any activity above the normal amount will cause a person to lose water faster and in greater quantity. This water must be replaced or the body will be in a state of dehydration. When dehydrated, the sweating process will slow and eventually stop, and this will cause body heat to rise. As the heat in body rises, it will cause physiological stresses to the body. Immediate treatment should consist of cooling the body and consuming enough water to promote the sweating process.

LET THE HELICOPTER COME TO YOU - Once the helicopter has reached the optimum position, it will begin to lower the pick-up device.

FOR LAND EXTRACTION Once the device has made contact with the ground, go to it.

NOTE: Some of these devices are very heavy; DO NOT STAND DIRECTLY UNDERNEATH THE PICK-UP DEVICE.

FOR SEA EXTRACTON: LET THE HELICOPTER COME TO YOU - As the helicopter approaches, it will typically drop the pick-up device in the water and drag it to your position. While this is occurring, you should partially deflate and sink the raft. This action will prevent the raft from becoming airborne and doing damage to the helicopter. Once the helicopter gets in the optimum position it will hover; you can then approach the device. Due to the down wash from the rotors, it will be very difficult to see. Always try to keep the device in sight.

ALLOW THE DEVICE TO TOUCH THE GROUND OR WATER- While the pick-up device is being lowered, there will be a build up of static electricity. If it is touched before it is allowed to discharge the electricity, it will deliver a respectable shock.

DON OR ENTER THE DEVICE - When using theSE devices, always look for the obvious. They have been designed for quick and easy use. Most devices will have simple one-word instructions, e.g., PULL.

WHEN SECURED TO THE DEVICE, LET RESCUE PERSONNEL KNOW When you are ready to be extracted, give a thumbs-up to the operator. In a sea extraction you can give a "splashing thumbs-up" as the operator may have difficulty seeing you through the rotor wash.

REMAIN STILL ON THE WAY UP - Do not grasp the cable or rescue hook. Hug the rescue device to you (i.e. strop or penetrator) or keep extremities inside the device 9 (i.e. rescue basket.) Usually, you will start to spin (most times, lightly) on the way up. Do not panic.

DO NOT ASSIST ENTERING THE HELICOPTER - Listen for instructions. Do not reach out. Maintain your lifting body position until told otherwise.

PICK-UP DEVICES

Survival has but one goal: RESCUE! That rescue can come in many forms. Anything from a hiker who just happened to be in the area, to a rescue helicopter hovering above can be a potential rescuer. The survivor's chief responsibility is to get the attention of the rescuer so that the survivor may be extracted from the survival environment. Extraction from a survival environment can be accomplished through many means. Many times, survivors must



be removed from an environment that is potentially dangerous to their well being as well as that of the rescuers. Heavy seas or rough terrain can play havoc with conventional rescue parties. In cases such as these it is likely that a helicopter will be used. Helicopters can get to areas that are impractical for other types of rescue vehicles. If a helicopter can land safely, it could literally land within feet of a survivor. If a safe landing cannot

be accomplished, then extraction, using a pick-up device, will be utilized. Rescue equipment used by military helicopter involves an electric winch, a cable with a hook attachment, and the pick-up device.

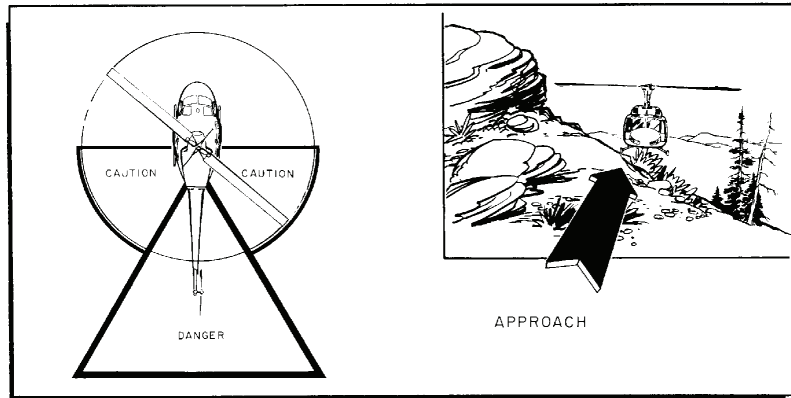

10-1 APPROACHING A RESCUE HELICOPTER. Illustration taken from AF Regulation 64-4.

Extraction can be accomplished on land or sea. The procedures for each are almost identical. If possible, rescue personnel will be lowered to assist. If rescue personnel can not be lowered, then there are a few basic guidelines to follow to assure a safe and quick pick-up:

- **Sunburn:** Sunburn is a result of unprotected skin absorbing too much of the ultra-violet rays from the sun. Sunburn is not a life threatening injury. It is considered to be a first-degree burn, and should be treated as such. The real problem with sunburn stems from two complications. First, in an attempt to cool the injury, mild sunburn will cause the body to produce more sweat than normal. Secondly, more severe sunburn will cause an impairment of sweat glands on the affected area. This will cause your body to build up heat faster than normal, which can bring on a more serious heat injury.

- **Sun blindness:** This is brought on by the over-exposure of the eyes to sunlight. Though common in desert areas, it can be prevented. When you are out and about on bright sunny days, wear the sunglasses located in the survival kit. Even prescription glasses will give some protection. Wearing a hat will also help. Some of the common symptoms are an itch, a reddish appearance, a burning sensation and possible swelling. If this happens to you or a crewmember, it's going to take time for it to heal. Cover both eyes for at least 18 hours and take aspirin (*take aspirin only if you have drinking water*) to combat the pain. Failing to treat for this condition can lead to a worsening of the problem, or even permanent damage.

- **Heat cramps:** When a body sweats profusely, not only is it losing water, it is also losing salt. When this happens, it can upset the electrolyte balance of your cells. The body will send signals that this is happening in the form of cramps. Heat cramps can affect any of the muscles, but will usually only affect the legs and the abdominal region. If suffering from heat cramps, you must get into the shade, slow the sweating, and drink water. Massage the legs to alleviate the cramps.

- **Heat exhaustion:** When the body is under the stress of heat, the blood near the surface of the skin has a tendency to pool. This pooling will deprive the vital organs and muscle of a good blood supply, and heat exhaustion can result. Symptoms often include heat cramps, a general weakness, moist skin (*as opposed to dry skin with heat stroke*), and a paleness of the skin (*as opposed to a redness as with heat stroke*). The skin doesn't feel hot to the touch; body temperature is near normal. Heat exhaustion can be serious. Get the victim to a cool shaded location and give him/her water. Fan the victim if necessary to keep him/her cool until help arrives.

- **Heat stroke:** While all heat related problems are serious, heat stroke has a high death rate and is considered the most serious. With heat stroke, all sweating ceases and the body rapidly builds up heat. The skin is red, hot, and dry to the touch. Sometimes the victim will be unconscious. Get the victim out of direct sunlight, and provide him/her with water. Administer salt-water solution (*unless unconscious*) and cool the victim rapidly. If a stream or pool

is near by, get victim in it. It is imperative that a physician or medical technician be sought as soon as rescue arrives.

As stated before, finding water in the desert will be a challenge. The water you have in the body system before a survival episode may be the only source. Don't waste it. A good rule of thumb to adhere to is to "ration your sweat, not your water." Here are a few techniques that may help you to conserve your internal water (*hydration*):

- Stay out of direct sunlight (*The shade can be 40 degrees cooler*)
- Stay off the desert floor (*12" above or 12" below may be 40 degrees cooler*)
- No activity during the daylight (*All work done at night*)
- Proper clothing (*Light colors reflect sunlight, keep clothing baggy and layered*)
- No smoking (*Smoking hastens dehydration*)
- No alcohol (*Alcohol promotes dehydration*)

When the thirst mechanism sends a signal to the brain, it's saying the body is low on water. Keep your system filled with water before you become a survivor.

If the time comes when water needs to be found, all work should be done in the cool of the night. Finding water in the desert may be difficult, but it is not impossible. An important question to ask is "Should I go out and look for water or stay put and conserve what is in my system?" An alternative may be to dig a solar still. A solar still brings moisture from the ground and air and puts it in a container for your consumption. To construct a solar still, first dig a hole, find a container, and have a clear piece of plastic available. (*See diagram*). Crushed green vegetation placed along the sides of the hole will speed up the moisturizing process. Additionally, if you dig your hole in a natural moisture collector (*see diagram*) it will help. One solar still may produce as much as 2 pints of water a day, but the quantity is usually far less. So, should you dig a solar still (*which will cause you to lose water through sweating*) or stay in the shade and conserve? It will be a judgment call.

The following 4 pages illustrate a person's average daily water requirement and various water procuring techniques and ideas. (*Information and illustrations were taken from USAF Regulation 64-4 unless otherwise noted*).

1. The Mod-1 survival kit:

(Circle the best answer)

- a. Has just the bare necessities for survival over 48 hours
- b. Weighs about 12 pounds
- c. Is designed to support six crewmembers for 72 hours
- d. All of the above

2. When should you inventory your survival kits?

(Circle the best answer)

- a. After aircraft evacuation and first aid has been rendered
- b. Immediately after the aircraft has come to a stop
- c. After you have set up your shelter
- d. When you require the use of a specific item in the kit

3. The purpose of a Personal Survival Kit is to _____ existing kits.

(Circle the best answer)

- a. Replace
- b. Augment
- c. Take the place of
- d. All of the above

4. A dual redundancy raft is one that:

(Circle the best answer)

- a. Has two cells to protect against sinking
- b. Has two colors
- c. The top is identical to the bottom
- d. Has two inflation (CO2) cylinders

5. Which survival kit will be used in conjunction with the 4-man and 6-man rafts?

(Circle the best answer)

- a. FA-1
- b. SRU/P Minimal survival kit
- c. MOD-1
- d. All of the above

- b. Liferaft - 6-Man - per TSO-C-70. Each raft is to be equipped with a locator light and survival kit that shall contain as a minimum the following:

<u>Quantity</u>	<u>Description</u>
1	Desalting kit or survivor 06 reverse osmosis hand pump
1	Dye marker
2	Emergency water container
If Required	Raft pressure relief valve plugs
1	Raft repair kit
1	Hand pump
1	Raft Knife
1	Bailing bucket
2	Sponge
1	Heaving – trailing line
1	Sea Anchor
1	Fishing Kit
1	Flashlight with batteries
1	Flare signal kit
1	EBC-102 emergency locator transmitter with flotation collar.

NOTE: A module-1 survival kit will be used in conjunction with the above liferaft survival kit and secured to the liferaft with a nylon retaining line.

9-12 LIFERAFT EQUIPMENT LIST(6-PERSON) Information taken from the FAA survival kit manual, T.I. 4158.1-25-1

WATER REQUIREMENTS

WITH NO WALKING AT ALL

MAXIMUM DAILY TEMPERATURE (°F) IN SHADE	AVAILABLE WATER PER MAN, U.S. QUARTS					
	<i>0</i>	<i>1 Qt</i>	<i>2 Qt</i>	<i>4 Qt</i>	<i>10 Qt</i>	<i>20 Qt</i>
	<i>DAYS OF EXPECTED SURVIVAL</i>					
120	<i>2</i>	<i>2</i>	<i>2</i>	<i>2.5</i>	<i>3</i>	<i>4.5</i>
110	<i>3</i>	<i>3</i>	<i>3.5</i>	<i>4</i>	<i>5</i>	<i>7</i>
100	<i>4</i>	<i>5.5</i>	<i>6</i>	<i>7</i>	<i>9.5</i>	<i>13.5</i>
90	<i>7</i>	<i>8</i>	<i>9</i>	<i>10.5</i>	<i>15</i>	<i>23</i>
80	<i>9</i>	<i>10</i>	<i>11</i>	<i>13</i>	<i>19</i>	<i>29</i>
70	<i>10</i>	<i>11</i>	<i>12</i>	<i>14</i>	<i>20.5</i>	<i>32</i>
60	<i>10</i>	<i>11</i>	<i>12</i>	<i>14</i>	<i>21</i>	<i>32</i>
50	<i>10</i>	<i>11</i>	<i>12</i>	<i>14.5</i>	<i>21</i>	<i>32</i>

WALKING AT NIGHT UNTIL EXHAUSTED
AND RESTING THEREAFTER

MAXIMUM DAILY TEMPERATURE (°F) IN SHADE	AVAILABLE WATER PER MAN, U.S. QUARTS					
	<i>0</i>	<i>1 Qt</i>	<i>2 Qt</i>	<i>4 Qt</i>	<i>10 Qt</i>	<i>20 Qt</i>
	<i>DAYS OF EXPECTED SURVIVAL</i>					
120	<i>1</i>	<i>2</i>	<i>2</i>	<i>2.5</i>	<i>3</i>	
110	<i>2</i>	<i>2</i>	<i>2.5</i>	<i>3</i>	<i>3.5</i>	
100	<i>3</i>	<i>3.5</i>	<i>3.5</i>	<i>4.5</i>	<i>5.5</i>	
90	<i>5</i>	<i>5.5</i>	<i>5.5</i>	<i>6.5</i>	<i>8</i>	
80	<i>7</i>	<i>7.5</i>	<i>8</i>	<i>9.5</i>	<i>11.5</i>	
70	<i>7.5</i>	<i>8</i>	<i>9</i>	<i>10.5</i>	<i>13.5</i>	
60	<i>8</i>	<i>8.5</i>	<i>9</i>	<i>11</i>	<i>14</i>	
50	<i>8</i>	<i>8.5</i>	<i>9</i>	<i>11</i>	<i>14</i>	

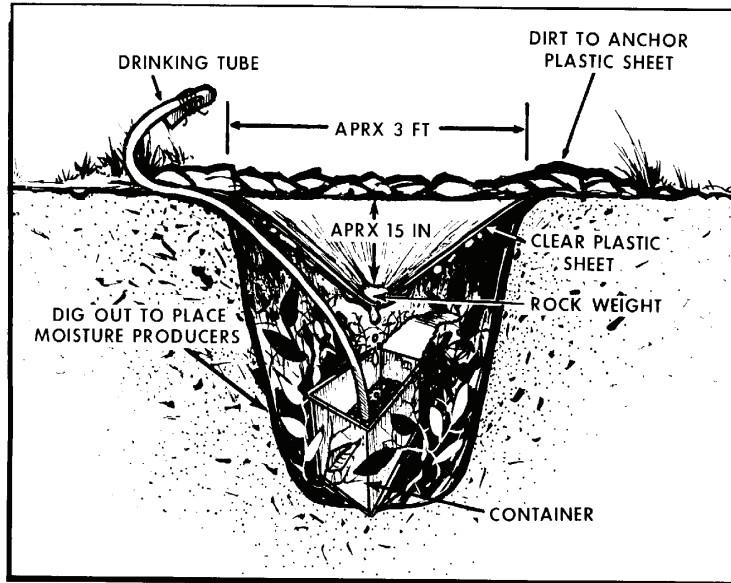

- b. Liferaft - 6-Man - per TSO-C-70. Each raft is to be equipped with a locator light and survival kit that shall contain as a minimum the following:

<u>Quantity</u>	<u>Description</u>
1	Desalting kit or survivor 06 reverse osmosis hand pump
1	Dye marker
2	Emergency water container
If Required	Raft pressure relief valve plugs
1	Raft repair kit
1	Hand pump
1	Raft Knife
1	Bailing bucket
2	Sponge
1	Heaving – trailing line
1	Sea Anchor
1	Fishing Kit
1	Flashlight with batteries
1	Flare signal kit
1	EBC-102 emergency locator transmitter with flotation collar.

9-11 LIFERAFT EQUIPMENT LIST(4-PERSON) Information taken from the FAA survival kit manual, T.I. 4158.1-25-1

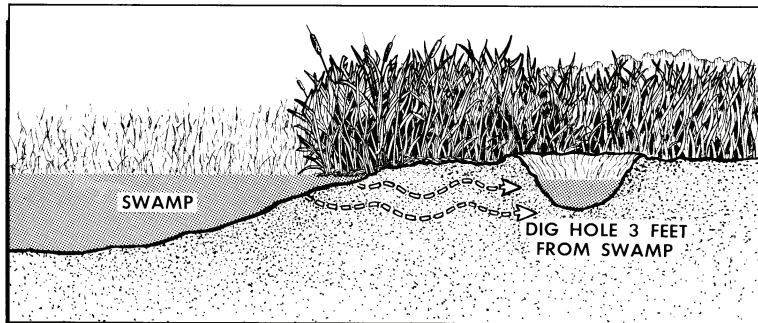

LIFERAFTS/SURVIVAL EQUIPMENT LIST

1. GENERAL

This chapter is issued to provide the minimum survival equipment list for all liferafts used on the FAA aircraft. This list will include the quantity and description of each item.

- a. Liferaft - 4-Man - per TSO-C-70. Each raft is to be equipped with a locator light and survival kit that shall contain as a minimum the following:

<u>Quantity</u>	<u>Description</u>
1	Desalting kit or survivor 06 reverse osmosis hand pump
1	Dye marker
1	Emergency water container
1	Raft repair kit
1	Hand pump
1	Raft Knife
1	Bailing bucket
2	Sponge
1	Heaving – trailing line
1	Sea Anchor
1	Fishing Kit
1	Flashlight with batteries
1	Flare signal kit

NOTE: A module-1 survival kit will be used in conjunction with the above liferaft survival kit and secured to the liferaft with a nylon retaining line.

9-10 LIFERAFT EQUIPMENT LIST(4-PERSON) Information taken from the FAA survival kit manual, T.I. 4158.1-25-1

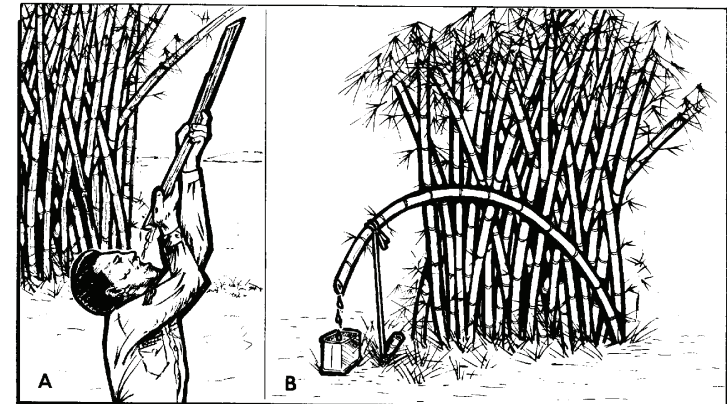
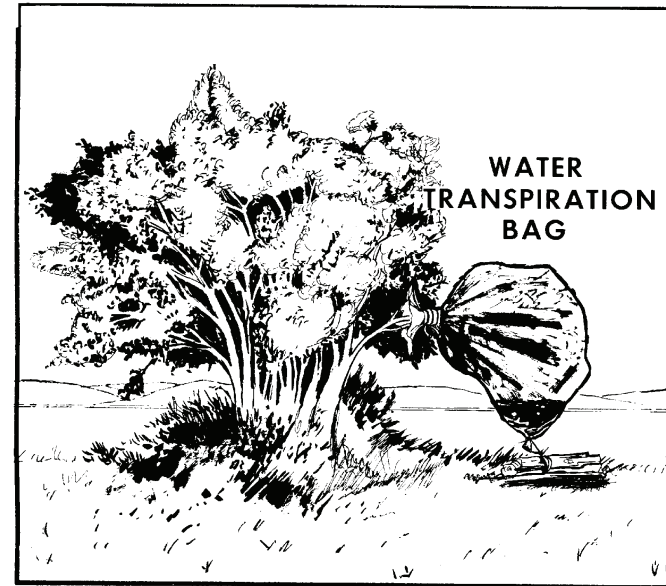

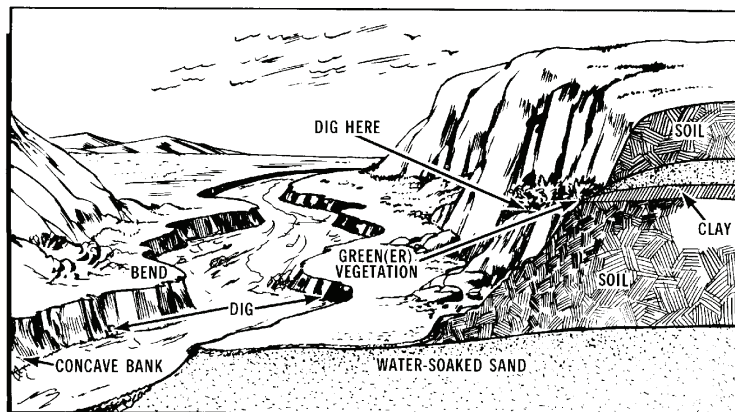
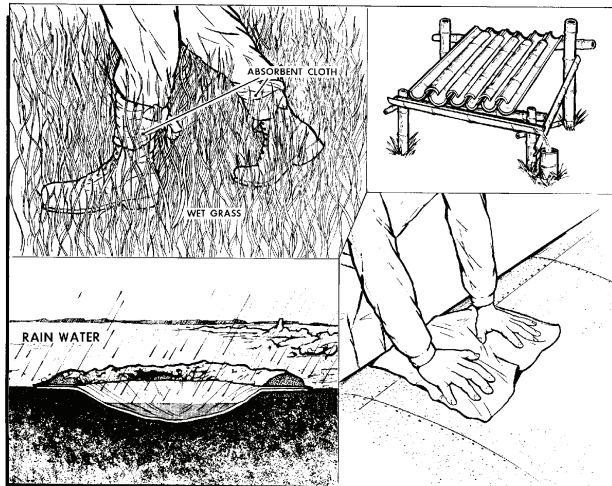

ISO-C70a, CAA BCAR-B4-8 & DGAC QACI-144 Approved Hard Pack Configuration

STANDARD EQUIPMENT Includes

- CO₂/N₂ Inflation System w/Twin Oversized Buoyancy Tubes
- Three (3) Position (Closed, Sail & Convertible) Light Weight Canopy w/Cincl
- Sure-Seal™ Closures w/#10YKK Heavy Duty Zippering
- Dual Main Zipper w/Ventilation Tie Backs
- Tripod Arch, Auto Inflatable, Canopy Support System w/Stay Erect Arch Support Valve System
- Oversized Front Boarding Entry w/4 Rung Boarding Ladder
- Interior Assist Ladder w/Quick-Release Fittings
- Rear Boarding Door w/3 Rung Boarding Ladder
- Five (5) Bowed Boarding Assist Handles
- Front Boarding Assist Stirrups (8 Person & Larger)
- Combination Foul Weather Observation Port Hole & Water Collection System w/Sure-saltam Closures
- 12DF™ Inflatable Insulated Double Floor
- Water Activated Interior/Exterior Survivor Locator Lights
- Quick-Grab™ Pelican® Magnum Flashlight on Arch
- Auto-Deploying Hemispherical Drogue (Sea-Anchor) w/25' Line & Anti-Foul
- 75' Floating Heaving Trailing Line w/Buoyant Throwing Handle
- 35' Painter Line w/Quick-Release Fittings
- Heavy Duty EZGrip™ Righting Line w/Contrasting Bowed Hand Grips
- Water Activated Righting Line w/Retrievable/Reusable Battery
- Unidirectional Retro/Radar Reflective Segments on Canopy
- Unidirectional Retro Reflective Segments Under Life Raft & Across Arch
- Pentagonal Ballast System™
- 1" Exterior Lifelines & Interior Grasp Lines
- Five (5) StoreSafe™ Light Weight Dry Survival Gear Storage Pockets
- Pressure Relief Valves

9-9 WINSLOW Ultra-Light standard equipment. Information provided by the Winslow Liferaft CO.

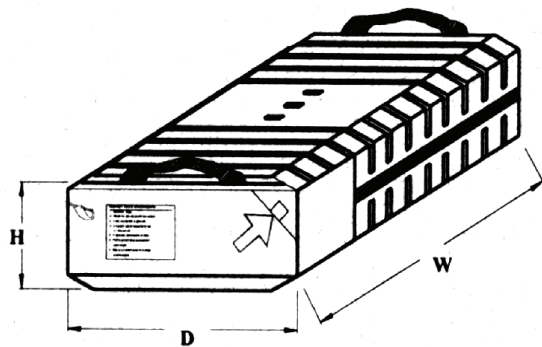
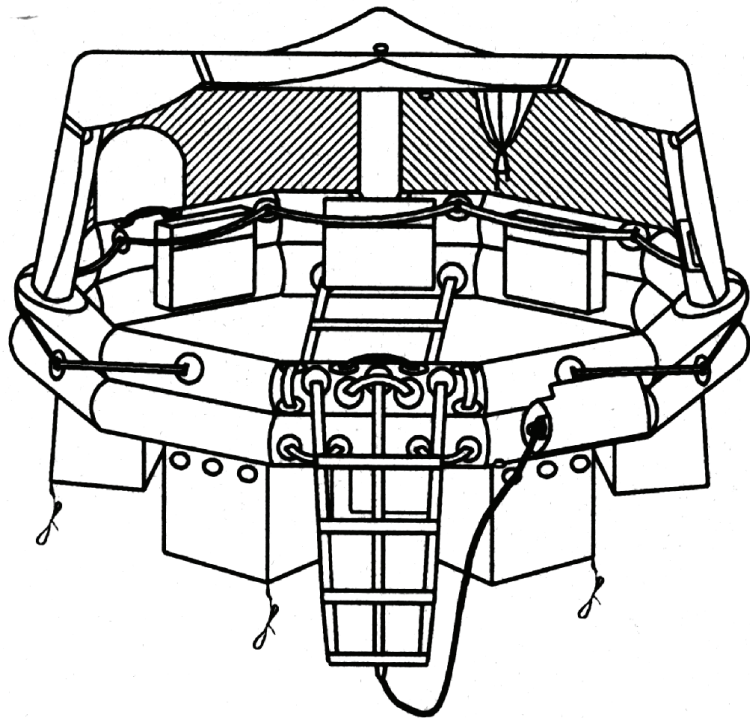

9-8 WINSLOW Ultra-Light standard equipment features. Information provided by the Winslow Liferaft CO.

Amount of water	Amount of solution to add	
	Clear water	Cloudy Water
1 quart (¼ gallon)	2 drops	4 drops
1 gallon	8 drops	16 drops
5 gallons	½ teaspoon	1 teaspoon

Add chlorine solution to water and stir. Let stand for 30 minutes. After this length of time, the water should have a distinct taste or smell of chlorine. If not, add several more drops of chlorine, and let stand an additional 15 minutes. The taste or smell of chlorine in the water is a sign of safety.

All the basic needs that a person has at home (*shelter, food, water, and first aid*) must still be satisfied while surviving in the desert. People of the desert have successfully used techniques of desert living for thousands of years. Building a fire while surviving in the desert may sound a little silly until you consider how cold it gets at night. The temperature can be 100 degrees or more during the day and then drop to below freezing at night. There have been cases of people freezing to death due to cold nights in the desert. An advantage of being in the desert is that everything is dry and anything will burn. Also, because of the vast open terrain of the desert, a fire makes an excellent signal.

A shelter in the desert will be needed to protect you from the sun during the day and the cold during the night. A shelter (*tarp*), suspended 18 inches, above the desert will provide shade that can be as much as 40 degrees cooler. By digging down 12 inches it can drop even further. A good idea is to layer the shelter. Layering creates a dead air space, which will help to insulate.

The need for food in the desert isn't as great as the need for water. Do not consume any dry food unless you have plenty of water.

Because of the dry desert climate, most external injuries will heal very quickly. But basic first aid will still be required. Keep wounds covered to protect from dirt and insects.

Hazardous wildlife, such as bees, snakes and scorpions, are negligible in the dessert. During the springtime when the desert is in bloom, bees are abundant. More people die each year from bee stings than from snake-

bites. If you, or a crewmember, are allergic to bee stings, be sure to carry a "Bee Sting" kit.

Snakes in the desert will usually shun from people if not provoked. There are two varieties of snakes found in the desert environment that are poisonous to man.

- **Copperhead:** Named for its copper colored head, the snake is typically about 5 feet in length.

- **Rattlesnake:** Named for rattlers located on its tail (*though some rattlesnakes don't have them*). They vary in length, depending on the breed, and are found throughout all North American deserts.

A majority of snakebites occur from the knee down when people are not watching where they are stepping. Often, a pair of boots or even jeans will help protect you. If bitten by a snake, and you are not positive as to what type of snake bit you, treat the bite as poisonous. The most important factor when treating snakebites is to keep the person calm. A person who panics and performs a lot of unnecessary activity is rushing the poison to its target. Keep in mind that only about 75% of the people who are bitten by a poisonous snake actually have venom in them from the bite. The recommendations for treatment are:

- Keep victim at rest and warm
- Give plenty of assurance that he/she will be all right.
- Remove all rings, bracelets, and watches (*if bitten on hand*)
- Remove shoes if bitten on the leg.

If more than 5 minutes has elapsed after the bite, apply a constricting bandage.

- The bandage should be at least 2" wide
- Apply 2" above and 2" below the bite
- Feel for pulse

Swelling, weakness, and pain are some common symptoms of snakebites. Other symptoms that might appear are:

- Numbness or tingling of mouth, scalp, and feet.
- Changes in pulse rate
- Faintness and dizziness
- Vomiting and nausea
- Respiratory rate changes

The best prevention for snakebites is to watch your step and don't

The newest raft to the flight inspection fleet is the Winslow Ultra-Light. It is designed as a 6-person raft with an overload of 9 persons. It will weigh almost 50 lb.'s and its dimensions will be approximately 8" x 17" x 28".

It is a good idea to tie down everything in the raft if possible. Keep the inside of the raft dry and it will be a much more pleasant environment.



9-7 WINSLOW 6-PERSON RAFT – Located on selected FAA Flight Inspection Aircraft

COMMON SENSE. Remember that survival situations rely heavily on common sense. Trust your instincts.

The rafts found on board FAA aircraft are designed to keep survivors afloat and sheltered from the water and elements until rescue arrives. Currently, the two rafts being used by the FAA Flight Inspections crews, are the SWITLIK 4 and 6 person rafts and the Winslow Ultralight 6 person. Both of these rafts have canopies, dual redundancy flotation cells (*automatically inflated when activated*), boarding ladders, internal lighting, ELT, and a safety knife.

The Switlik 6-person raft comes packed in a container that measures 3 feet in height and about 18 inches thick. It weighs about 64 pounds. When the inflation lanyard is pulled, the raft will automatically inflate. A carbon dioxide cylinder will fill the top and bottom cell. The top cell will also inflate the canopy. Once inside the raft, you should inflate the floor for protection from the cold water and to help stabilize the raft. Also, you should deploy the sea anchor and adjust it to the proper length.

The Switlik 4-person raft, like the 6-person, will automatically inflate when activated. Although there isn't a top and bottom cell on the 4-person raft, a bladder within the cell will automatically inflate when a leak occurs. On the 4-person raft, the canopy must be manually erected. Once in this raft, you should go ahead and deploy and adjust the sea anchor. Every raft will have its own accessory kit. Inventory these items and have them ready for quick use. Illustrations' 9- and 9-6 show the 4-person raft and an example of the buoyancy tube redundancy.

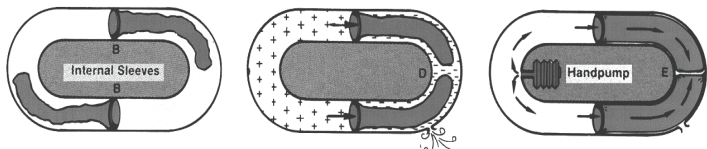
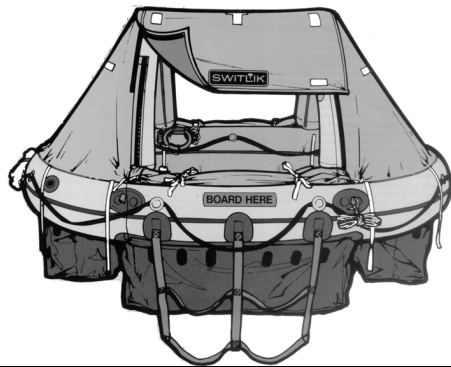

9-5 SWITLICK COASTAL LIFE RAFT. 9-6 RAFT BUOYANCY TUBE REDUNDANCY

provoke or try to capture any snake.

Scorpions are also native to most deserts. Always look before you sit or lie down. Always check shoes and clothing before donning. All scorpions are poisonous, but not deadly. If you or a crewmember is stung, keep calm and watch for complications, though it is doubtful that any will occur.



HOTLAND SURVIVAL **Chapter Quiz**

1. The three types of deserts are:

(Circle the best answer)

- a. Northern, southern, and equatorial
- b. Hot, arid, and temperate
- c. Sand, rock, and salt
- d. Mountainous, flats, and mesas

2. Ration your _____ not your _____.

3. The average person loses how many quarts of water a day through everyday activity?

(Circle the best answer)

- a. 1-3
- b. 2-4
- c. 3-5
- d. 5-6

4. The most serious heat related illness is _____.

(Circle the best answer)

- a. Sunburn
- b. Heat exhaustion
- c. Heat Stroke
- d. Heat cramps

5. Which of the following is not a concern in a hotland environment?

(Circle the best answer)

- a. Heatstroke
- b. Hypothermia
- c. Hyperthermia
- d. All are a concern

COLDLAND SURVIVAL

A "Cold Land" exists when there is cold sufficient enough to cause harm to the body. Cold usually brings to mind the classic Arctic environment, although a "Cold Land" can exist over any region you fly. Hypothermia, the greatest threat in a cold land, is common in temperatures that are just less than 50 degrees F. A little sweat and wind, coupled with inadequate clothing, can add up to trouble. A big problem in flying over a cold land is that most crews dress for the cockpit environment, and not for the cold land. If the aircraft goes down, the result is an unprepared crew in a hostile environment. Knowledge and preparation are your two best allies against this potential threat.

The human body is best suited for tropical or semi-tropical areas of the globe. An unprotected human cannot withstand extreme temperature changes. As the ambient temperature drops, the body's core temperature also drops. This is known as hypothermia (*also known as exposure*). Through the process of metabolism, the body core maintains a temperature of 99 degrees F. Heat produced by metabolism is circulated throughout the body. As long as heat loss does not exceed heat build-up, the body will function normally. But, if heat is lost from the body too quickly, this will lower the core temperature. As the body core temperature drops, so does mental and physical efficiency. Heat is lost from the body through several different vehicles:

- CONDUCTION** • The primary cause of heat loss.
 - A transfer of heat occurs when the body comes in contact with something colder than itself.
- RADIATION** • The body will continually radiate heat from exposed areas.
 - 50% of body heat is lost from the head.
- CONVECTION** • Air current blows heat away from the body faster than it is produced.
- EVAPORATION** • Sweat (or other moisture) can moisten clothing and accelerate conduction.
- RESPIRATION** • In a cold environment, cold air enters the body and leaves as warm air. The body loses heat by warming the colder air.

Once body core temperature starts to drop, the body will begin to defend itself against the cold. Capillaries and smaller vessels near the surface of the skin will constrict to keep the blood from coming in contact with the cooler surface. This gives the skin a bluish or ashy color. Shivering will usually be

LSK - 2

1. 1 Leatherman Multi-tool
2. Magnifying glass
3. 1 U-Dig-It shovel
4. 1 pack of Gyro Jet signal flares
5. Wet fire tinder (2 packs)
6. Firefly signal strobe light
7. 2 krill lights
8. 1 tube of OFF insect repellent/sunscreen
9. 1 knife sharpener
10. 1 bottle of no-rinse body wash

9-3 LIFE SAVING KIT (LSK-2) CONTENTS (Located in the interior of the Mod-1 kit.)

LSK - 3

1. 3 packs of Datrex Survival Food (7200 calories)

9-4 LIFE SAVING KIT (LSK-3) CONTENTS (Located in the interior of the Mod-1 kit.)

Every item in each kit has an intended purpose. Also, every item has an improvised use. Keep an open mind when doing an inventory of the kit contents. One of the first things that should be done, after aircraft evacuation and first aid has been rendered to the injured, is to inventory all the survival equipment. After inventory, separate and group all equipment and have it ready for quick use.

Even though these kits are well stocked, there is always room for improvement. This is when a personal survival kit would come in handy. A personal survival kit is designed to supplement existing kits. As a general rule, do not duplicate items already present in FAA kits. Variety has been called the spice of life. Variety can also spice up your kit. So take a good look at the environment you fly over and consider your personal needs to give you some idea of how to stock a personal survival kit. What would you consider the most important item to put in a personal survival kit?

	Item	Qty
	1 - Blast match	
	1 - Signal mirror	
	1 - Jetscream emergency whistle	
	2 - Cubes of Wetfire tender	
15.	Ultimate Signal Kit	1
	2 - Aerial signal flares	
	1 - orange smoke flare	
	1 - Sea dye marker	
	2 - Emergency whistles	
	1 - Signal mirror	
	1 - Submersible flashlight	
	1 - Distress flag/emergency shelter	
	1 - Thermal blanket	
	3 - Campfire starters	
	2 - Candles (4 hr.)	
	1 - Canister of emergency matches (10)	
	1 - Signal and survival guide brochure	
	1 - Belt pouch	

9-1 MOD-1 KIT CONTENTS

LSK - 1	
1.	Adventure medical kit
2.	6-12 Insect repellent
3.	Eyeglass repair kit
4.	USAF Pamphlet 64-5, survival manual
5.	Military issued insect repellent
6.	2 canisters of wind/water proof matches (25 per)
7.	1 pair cotton gloves
8.	1 MK-13 Day/Nite signal flare

9-2 LIFE SAVING KIT (LSK-1) CONTENTS (Located in the interior of the Mod-1 kit.)

the next major symptom. This is the body's attempt to produce heat through muscular contraction. It will usually start out mild, then progress to a more violent form. As muscles begin to cool and stiffen, muscular coordination is lost. Speech will also be slurred as mental faculties and judgment begins to slow. The pulse becomes weak and irregular as the blood cools and thickens. Unconsciousness may be only minutes away due to hypoxia. Another important fact concerning hypothermia is, fatigue that will hasten its onset.

The first line of defense against hypothermia is shelter. Clothing is considered shelter, in the sense that it is your first immediate measure to retain body heat. The primary method of retaining heat is to insulate. The insulative quality of any material is dependent on the amount of trapped air in the material. An important fact to keep in mind is that when clothing becomes wet, it will lose its insulative quality. Wet clothing in wind will draw off body heat 200 times faster than wind alone. Wool is one of the best insulating materials. Wool will insulate even when it becomes wet. A general rule on dressing for a cold land is to wear a layer of cotton next to the skin (*to absorb and retain moisture*), followed by a layer of wool, then a water resistant material on top.

Shelter from the elements needs to be constructed as soon as time and conditions permit. Materials to construct a shelter may be scarce. The most readily available shelter at your disposal is the aircraft fuselage. During inclement weather it will give protection from the elements. It is important to keep in mind that, if the temperature is below 10 degrees, other shelter should be sought. The metal in the fuselage will act as a cold sink and draw heat from the body. Another readily available shelter is the raft. Once it is inflated, it will give adequate protection from the elements. No matter what type of shelter used, there are a few basic guidelines:

Location - Stay near the aircraft. Air rescue parties will be looking for it. Stay near it and have signal ready for quick use. Look for any possible hazards when selecting a site for shelter. Dead trees could lose their tops, or limbs, and could fall on the shelter. Look for the possibility of an avalanche or rockslide area. Because of the risk of flash floods, stay out of dry streambeds. If possible, place the shelter under the tree line to give added overhead protection from the elements.

Material - Many aircraft parts can be used for a shelter. The aircraft's interior has many more resources than the exterior. Fabric on the seats, floors, and walls can be readily used. Natural foliage, such as leaves, grass, and tree boughs are there for the taking. Snow and ice can also be used as material to build a shelter. Although they are very cold, they make excellent insulation for existing shelters.

FAA KITS, RAFTS, and ACCESSORIES

There have been several accounts of people who have perished even though they had the necessary equipment to survive. A big percentage of these deaths have been attributed to lack of knowledge...lack of knowledge of the equipment they had and how to use it. The FAA has placed survival kits and rafts aboard the aircraft in the event you are faced with a survival situation. Knowing what's in the kits and how to properly use the items, will greatly enhance your chances of walking away from a survival situation.

The kits found aboard FAA aircraft have been designed for long term survival situations.

The Module-1 (*MOD-1*) kit is designed to help 4 people survive for 72 hours. As with the FA-1 kit, it will be inspected by Personnel Equipment every 12 months. But again, check the lead seal for evidence of tampering. The MOD-1 kit weighs about 30 pounds and measures 22 inches long, 12 inches wide and 5 inches high. This kit contains the following items:

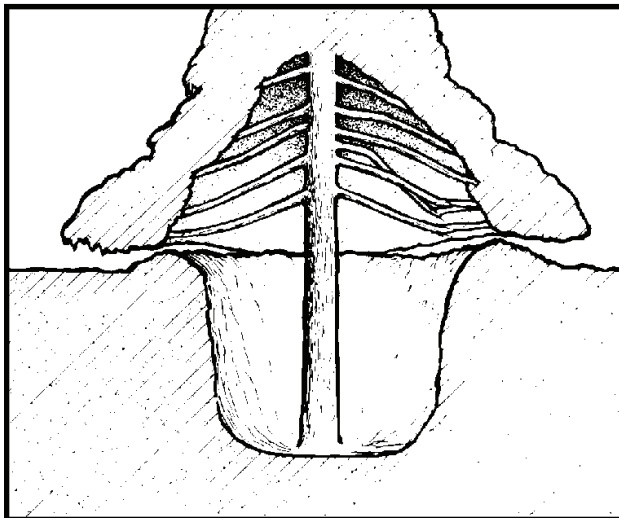
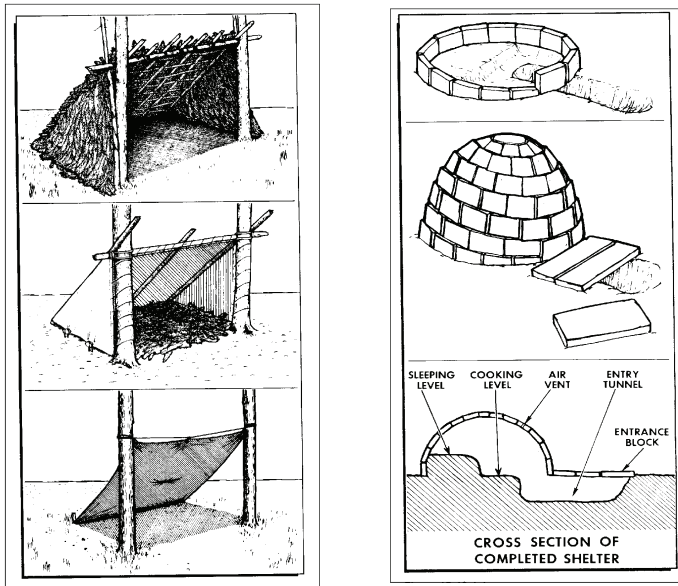

Item		Qty
1.	Two-man tube tent	3
2.	Large trash bags	3
3.	Solar-still kits	2
4.	Praddles (oars)	2
5.	Military style survival knife	1
6.	Parachute cord	100'
7.	Techtest 500-27 406 MHz PLB	1
8.	Water packets (2 quarts)	16
9.	Sunglasses	4
10.	Emergency bags	4
11.	Sam splint	1
12.	Roll of duct tape	1
13.	Greatland Rescue Laser Flare	1
14.	Ultimate Survival Kit	1
	1 - Sabrecut saw	

SURVIVAL KITS AND ACCESSORIES

Chapter Quiz

1. Which is the least important priority?

(Circle the best answer)

- a. First-aid
- b. Shelter
- c. Rest
- d. Water
- e. Food

2. If you decide to purchase a raft you should buy one that provides enough space for:

(Circle the best answer)

- a. The pilot
- b. The pilot and one passenger
- c. The pilot and two passengers
- d. The pilot and the maximum load of passengers you plan to carry on any one given flight.

3. You should choose a raft that fits your needs, regardless of size and weight?

(Circle the best answer)

TRUE

FALSE

4. A PSK that is thoughtfully put together is all you will ever really need in a survival situation.

(Circle the correct answer)

TRUE

FALSE

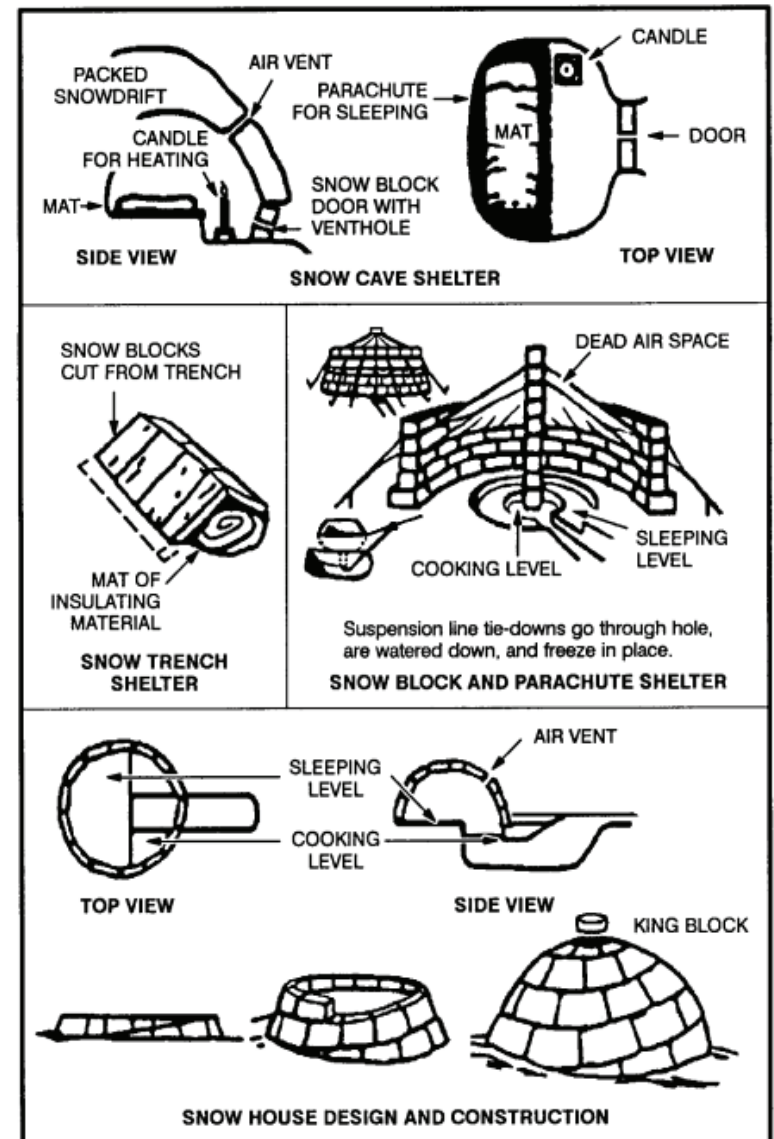

Illustrations 5-1 through 5-4 demonstrate cold land survival shelters. (Information and illustrations were taken from USAF Regulation 64-4 unless otherwise noted).

Fuel Source - Stay near the resources needed to maintain a fire. If there is too much distance between the site and the resources, precious energy will be expended to maintain the fire.

Water Source - Being close to the water source is one primary consideration. Although it is wise to stay close to a water source, do not construct the shelter too close to these areas, as they are typically cooler and damper.

Signaling - If possible, select a site that will allow a signal to be seen from all directions. As a general rule, if you can't see them, they can't see you. Remember that the most promising signal is the aircraft wreckage. Keep it visible and stay near it.

The effectiveness of any shelter lies in its insulation. As mentioned above, the best insulation that is readily available is snow. But, if you have covered the shelter with snow, it is no longer an effective signal. Once inside the shelter, body heat will begin to warm the inside. Scraping down to bare earth will increase the inside temperature to about 12 degrees, even if it is sub-zero outside. By lighting a candle, it is possible to raise the temperature by another 4 degrees. Keep the shelter just big enough to accommodate you and your co-survivors. This will make the shelter easier to warm. The life raft on board the aircraft makes this easy and there is no construction involved.

Medical problems associated with cold land survival are preventable if a few precautionary measures are taken:

Hypothermia - The average body temperature for the human body is 98.6°F. Any deviation from this normal temperature, even as little as one to two degrees, will reduce efficiency. Hypothermia, or "exposure", is defined as body core temperature less than 95°F.

°F	°C	Signs & Symptoms
99—96	37—35.6	Intense shivering and impaired ability to perform complex tasks.
95—91	35—32.8	Violent shivering, difficulty in speaking, sluggish thinking, amnesia

PART	USE
Clearance Light Covers -	Utensils and tools.
Wheel Flaring -	Water storage or collection; if broken will produce black smoke in fire.
Tires -	Fire starting, signaling with black smoke.
Inner Tubes -	Cut hole for canteen, cut into strips for elastic bandage, burn for black smoke.
Bungee Cord on Older Aircraft -	Sling material for slingshot.
Windows -	Water collection, solar still, or burn for black smoke.
Ailerons -	Snow cutting tool, shelter braces, splints.
Wiring -	Binding, cordage and rope.
Air Filter -	Fire starting, improvised water filter.
Oil Filter -	Burn for black smoke.
Hoses -	Siphoning, burn for black smoke.
Landing Light Lens -	Fire starting.
Compass -	Establishing direction for signaling and also oil for fire starting (<i>Kerosene</i>).
Rotating Beacon Lens -	Cup
Seatbelts -	Binding material slings bandages.
Battery Box -	Stove or a container to cook in.
Brake Fluid and Kerosene from Turn and Bank Indicator -	Fire starter
Magnesium Wheels and Disc Brake Plates -	Signaling

<i>PART</i>	<i>USE</i>
Fuselage -	Moderate weather shelter.
Wings -	Wind breaks, shelter support, overhead shade, platform for fire on snow, water collection for dew and rain, signal if laid out in clearing.
Vertical Stabilizer -	Shelter support, platform, water filter when inverted.
Aluminum Skin -	Reflector for warmth around fire, signal, reflector oven, shade, fire platform, splint material, snow saw blade.
Fabric Skin -	Fire starting material, water collection.
Engine Oil and Gas -	Fire starter and fuel for stove, signal with black smoke.
Engine Mags -	Spark producer for fire starting.
Engine Cowls -	Shelter, water collection, windbreak, fire platform
Nose Spinner Cone -	Bucket, stove, scooping tool in snow, container for solar still, pot for heating water and cooking, funnels.
Propeller -	Shovel, snow cutting tool, bracing for shelter.
Wing Struts -	Pry bar, splint, shelter brace, flagpole, crutch.
Landing Lights, Strobes and Clearance Lights -	Signal when used with battery.
Fuel Cells -	Melt snow on black surface, black smoke in fire, lay on snow for signal, inside lining of shelter.
Spring Steel Landing Gear -	Pry bar, splint brace.
Wooden Wing Struts, Braces and Props on Older Aircraft -	Fire starter and fuels.
Doors -	Shelter, solar still using windows, shade, windbreak.
Seats -	Sleeping cushion, back brace for spinal injury, sponge rubber for fire starting and signaling, padding for splints, sponge rubber for neck support.
Head Liner and Other Fabrics -	Water strainer or filter, clothing, and bandage.
Rugs -	Ground padding, insulation, clothing, overhead shade.
Air Charts/Maps -	Stuff inside clothing for added insulation.
Battery -	Signaling with lights, fire starting.
Control Cables -	Rope, snares, binding for shelter, repair cord.
Control Pulleys and Cable -	Block and tackle.
Wing Tips -	Drip collectors and water carriers.

°F	°C	Signs & Symptoms
90 - 86	32.2—30	Shivering is replaced by muscular rigidity. Exposed skin is blue or puffy. Movements are jerky. Dulled sensorium, but patient still is able to maintain posture and the appearance of contact with surroundings.
85—81	29.4—27.2	Coma, lack of reflexes, arterial fibrillation.
Below 78	Below 25.6	Failure of cardiac and respiratory centers, pulmonary edema, ventricular fibrillation. Death

5-5 Information taken from The National Ski Patrol's "OUTDOOR EMERGENCY CARE" Second Edition, 1993

There have been cases in which survivors have endured prolonged exposure to extreme cold and dampness through exercise, shelter, and food. Wearing the proper clothing for the environment and having the proper climatic survival equipment when flying over cold climate areas will greatly enhance your chances of survival.

Snow blindness - It is a condition where the eyes have absorbed too much sunlight. In snow-laden areas, the sun's rays are reflected from the snow to the eyes. Redness and burning are the primary symptoms. Headache, poor vision, pains, and swelling might also accompany the primary symptoms. Prevention is the best medicine. When out on sunny days, wear some type of protective eyewear. The survival kits have sunglasses. Use them! Even prescription glasses will afford some protection. Treatment for snow blindness includes covering both eyes for 18 hours and applying a cold compress to relieve pain and swelling.

Frostnip - This is the freezing of the superficial layers of skin. It is caused as a result of skin exposed to cold and windy conditions. Symptoms include a whitening (*or ashing*) of the affected area, with a waxy texture. Finger tips, earlobes, nose, cheeks, and chin are the areas most vulnerable. To prevent frostnip from happening, keep a close watch for symptoms to appear. Adequate clothing is a must. When outside of the shelter, keep all body areas covered. Treatment is very simple! Warm the affected area with body heat and protect the affected area from further freezing.

Frostbite - This is the freezing of tissues, which includes the skin, muscles, tendons, and bone. When the cells in tissue freeze, all cellular activity ceases. Ice crystals form and draw water from the cell. This leaves the cell very vulnerable to damage. Also, the cells can no longer take up oxygen and eliminate waste products. Symptoms of frostbite include a waxy skin color and texture that is resilient to the touch. There is also a deep numbness to the affected area. The hands and feet are the areas mostly affected. A very important fact to remember is that once a limb becomes frost bitten, it is more susceptible to succumbing to this problem once again. To prevent this problem, always try to keep the feet warm and dry. When handling cold items or snow, wear gloves. If you do fall victim to frostbite, treatment in the field will be extremely limited. The best advice is to cover and protect the frozen area from further freezing until medical help can be sought. **DO NOT MASSAGE THE FROZEN AREA.** This could damage the tissues beyond repair. **DO NOT RUB WITH SNOW.** This will promote a deeper frostbite. **DO NOT SOAK IN KEROSENE.** This is just old wives' tale. **DO NOT TRY TO THAW THE AREA IN HOT WATER.** This is a very painful process and could cause further complications.

Dehydration - Dehydration, in a cold environment, may sound a little strange. But if care is not taken, a person could slip into dehydration very quickly. The thirst mechanism will be weakened and could reach the point where it is totally ignored. Remember, just because you have entered a cool environment does not mean your water requirements have changed. For a more in-depth discussion on this problem, refer to Hotland Survival. Finding water will be easy enough, but remember, you should not consume water unless it has been purified. Boiling water for 5 minutes or utilizing the water purification tablets will be the easiest methods. Never eat snow. The snow crystals can cause damage to the mouth and tongue and will also lower body core temperature. Place the snow in a leak proof container and set it next to the fire to melt or, place it between layers of clothing.

Survival in Cold Land is possible and can be made less difficult if a little common sense is used. Work with the environment and use all its resources to your advantage.

<u>MINIMUM ESSENTIAL ITEMS</u>	<u>GOOD TO HAVE ITEMS</u>	<u>ADDITIONAL SUGGESTIONS</u>	<u>INDIVIDUAL MEDICAL KIT</u>
Plastic or metallic container	Safety pins (several sizes)	Fish line monofilament	Additional medications may be
-Waterproof kitchen-type matches	Travel razor	Clear plastic bags	desirable, depending upon nature of
Waterproof matches rolled in paraffin-soaked muslin in an easily opened container such as small soapbox, toothbrush case, etc.	Small steel mirror	Emergency ration can opener (can be taped shut and strung on dog tag chain)	the mission and an individuals particular personal needs
Needles - sail makers, surgeons, and darning - at least one of each	6" flat file	Split shot - for fishing sinkers	<i>This should be discussed with your local AME.</i>
Assorted fishhooks in heavy foil, tin, or plastic holders	Aluminum foil	Gill net	
Snare wire - small hank		Small high quality candles	
Multi-tool		Candy	
Bar of surgical soap or hand soap containing pHisoHex			
Small fire starter of paraffin metal (some plastic match cases have a strip of the metal anchored on the bottom outside of the case)			
Personal medicines			
Water purification tablets			
"Band-Aids"			
Insect repellent stick			
Chapstick			

been in use for more than 1 cumulative hour, or, when 50 percent of their useful life (or for rechargeable batteries, 50 percent of their useful life of charge) has expired, as established by the transmitter manufacturer under its approval. The new expiration date for replacing (or recharging) the battery must be legibly marked on the outside of the transmitter. The battery useful life (or useful life of charge) requirements of this paragraph do not apply to batteries (such as water activated batteries) that are essentially unaffected during probable storage intervals.

Technical Standard Order (TSO) C70a, will provide you with the latest information concerning the minimum standards that liferafts must meet. This TSO will also address the FAA standards for liferafts.

As mentioned before, you can improve your chance of survival by using your imagination. This rule applies not only to your kits, but to all aspects of survival as well. This means that you should look at everything as a possible survival tool. With this in mind a list of improvised uses of the aircraft has been provided on the following two pages.

PERSONAL SURVIVAL KITS

<u>MINIMUM ESSENTIAL ITEMS</u>	<u>GOOD TO HAVE ITEMS</u>	<u>ADDITIONAL SUGGESTIONS</u>	<u>INDIVIDUAL MEDICAL KIT</u>
High quality pocket knife with at least two cutting blades.	Flares	Tooth-brush-small type	Sterile gauze compress bandage
ELT w/ GPS capability	Colored Cloth or scarf for signaling	Surgical tape	Antibiotic ointment (Neomycin polymyxin bacitracin ophthalmic ointment is good)
Cell or Satellite phone	Plastic water bottle	Prophylactics (make good waterproof containers or canteens)	Tincture of zephrine - skin antiseptic
Pocket compass	Flexible saw	Penlight with batteries	Aspirin tablets
Match safe with matches	Sharpening stone	Fish line	Salt tablets

Suggested Item List

COLD LAND SURVIVAL

Chapter Quiz

1. Hypothermia is defined as:

(Circle the best answer)

- a. A lowering of the inner-core body temperature
- b. Being exposed to cold temperatures
- c. Decreased breathing due to extreme cold temperatures
- d. Increased breathing due to extreme hot temperatures

2. What are the five ways in which the body loses heat?

_____, _____, _____,
 _____, _____.

3. What is the first line of defense against hypothermia? _____.

(Circle the best answer)

- a. First-aid
- b. Hot fluids
- c. Shelter
- d. Ice packs

4. Where will you find your most immediate source of shelter from the elements?

(Circle the best answer)

- a. Aircraft
- b. Cave or other form of natural shelter
- c. Raft
- d. Clothing (*Those being worn at that time*)

5. Wet clothing in the wind will draw off body heat _____ times faster than wind alone.

(Circle the best answer)

- a. 50 times
- b. 100 times
- c. 150 times
- d. 200 times

TROPICAL SURVIVAL

When you think about surviving in the Tropics, the classic jungle that we see in the movies is typically what comes to mind. Large trees covering the sky, letting little to no light penetrate to the floor below. Thick foliage on the ground requires a machete to cut your way through. As you envision a post-crash survival scenario, you probably imagine yourself dressed in khaki, hacking out a trail through the dense undergrowth as drums beat and hostile warriors try to pick you off with their spears and blowguns. The idea of surviving in the jungle makes most people grimace. Not only is survival possible in the jungle, many people actually live there. In fact, the requirements to survive in the jungle are no different from any other environment; first aid, shelter, rest, water, and food.

The jungle is an extraordinary environment, one that produces and nourishes many life forms. Life forms, in the jungle, will seek any stagnant form to grow upon. If you stay stagnant too long you will also become a breeding ground for these life forms. The key to survival in the jungle is to be aware of your surroundings, just as those people who have thrived in the jungle for centuries.

There are various forms of jungles, and are most common in tropical areas such as Southeast Asia, Africa, and Latin America. The climate in these jungles will vary with its proximity to the equator. Those close to the equator tend to have all seasons similar in nature, with rains throughout the year. Those further from the equator will have distinct wet seasons. Those wet seasons can include monsoons, typhoons and hurricanes. Both zones are characterized by nearly 90% humidity throughout the year with temperatures ranging from 78 to 95+ degrees Fahrenheit. Heavy rainfall is also common, often accompanied by thunder and lightning. Annual rainfall can reach 400 inches.

A variety of jungles exist and they can be broken down to the following categories:

- Rain forests
- Secondary jungles
- Semi-evergreen seasonal and monsoon forests
- Scrub and thorn forests
- Savannas
- Saltwater swamps
- Freshwater swamps

(i) One survival kit, appropriately equipped for the route to be flown; or

(ii) One canopy (for sail, sunshade, or rain catcher);

(iii) One radar reflector;

(iv) One life raft repair kit;

(v) One bailing bucket;

(vi) One signaling mirror;

(vii) One police whistle;

(viii) One raft knife;

(ix) One CO2 bottle for emergency inflation;

(x) One inflation pump;

(xi) Two oars;

(xii) One 75-foot retaining line;

(xiii) One magnetic compass;

(xiv) One dye marker;

(xv) One flashlight having at least two size "D" cells or equivalent;

(xvi) A two-day supply of emergency food rations supplying at least 1,000 calories per day for each person;

(xvii) For each two persons the raft is rated to carry, two pints of water or one seawater desalting kit;

(xviii) One fishing kit; and

(xix) One book on survival appropriate for the area in which the aircraft is operated.

(c) No person may operate an airplane in extended overwater operations unless there is attached to one of the life rafts required by paragraph (a) of this section, an approved survival type emergency locator transmitter. Batteries used in this transmitter must be replaced (or recharged, if the battery is rechargeable) when the transmitter has

(xviii) One fishing kit; and

(xix) One book on survival appropriate for the area in which the airplane is operated.

(b) No person may operate an airplane in extended overwater operations unless there is attached to one of the life rafts required by paragraph (a) of this section, an approved survival type emergency locator transmitter. Batteries used in this transmitter must be replaced (or recharged, if the batteries are rechargeable) when the transmitter has been in use for more than one cumulative hour, or, when 50 percent of their useful life (or for rechargeable batteries, 50 percent of their useful life of charge) has expired, as established by the transmitter manufacturer under its approval. The new expiration date for replacing (or recharging) the battery must be legibly marked on the outside of the transmitter. The battery useful life (or useful life of charge) requirements of this paragraph do not apply to batteries (such as water activated batteries) that are essentially unaffected during probable storage intervals.

135.167 Emergency equipment: Extended overwater operations.

(a) No person may operate an aircraft in extended overwater operations unless it carries, installed in conspicuously marked locations easily accessible to the occupants if a ditching occurs, the following equipment:

(1) An approved life preserver equipped with an approved survivor locator light for each occupant of the aircraft. The life preserver must be easily accessible to each seated occupant.

(2) Enough approved life rafts of a rated capacity and buoyancy to accommodate the occupants of the aircraft.

(b) Each life raft required by paragraph (a) of this section must be equipped with or contain at least the following:

(1) One approved survivor locator light.

(2) One approved pyrotechnic signaling device.

(3) Either -

Tropical Rain Forests

Tropical forests are located in the well-known Amazon and Congo basins, as well as parts of Indonesia, and several Pacific islands. Rainfall averages can reach 33 feet a year.

The landscape is filled with up-to five layers of vegetation. Large trees reaching heights near 200 feet produce the top layer. Smaller trees form the lower levels, making light from above nearly impossible to reach the jungle floor. The tree foliage, along with vines and lianas, make the jungles lower layers a dark and damp breeding ground for a multitude of plant life. Plant life, which includes ferns, mosses, herbaceous plants, and a great variety of fungi. Due to the lack of light reaching the ground, the jungle floor in these regions is usually barren. There is actually little undergrowth to hamper travel afoot. However, the ground is usually soggy, making vehicular travel a bit more difficult. Travel afoot is made difficult as well, due to the limited visibility, making it easy to become disoriented. The dense foliage also makes it very difficult for rescue crews to spot you from the air.

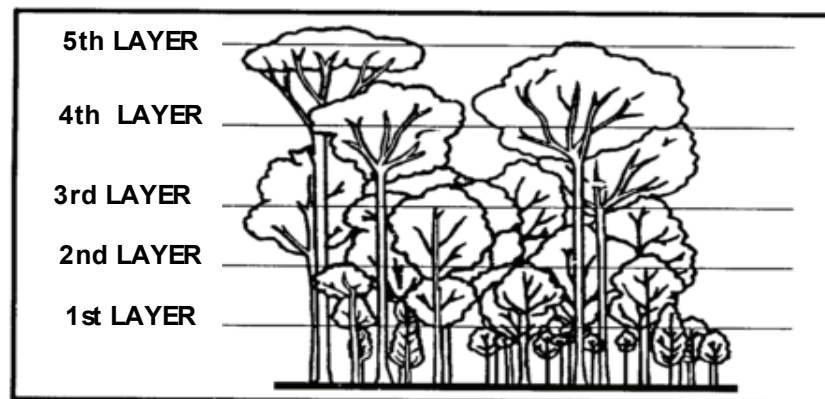

Secondary Jungles

A secondary jungle is very similar to a rain forest but with a dense undergrowth. The undergrowth occurs due to sunlight penetrating to the jungle floor. Secondary jungles are usually located near riverbanks and jungle fringes. However, clear cutting of the rain forest is producing more and more secondary jungles. Once the clear cutting operation is over, the jungle vegetation quickly impedes upon the cleared area.

Semi-evergreen Seasonal and Monsoon Forests

Semi-evergreen seasonal and monsoon forest jungles are found in South America, Africa, and Asia. Two distinct layers of foliage characterize them. The upper portions consist of trees reaching heights of 60 to 80 feet. While the lower levels reach heights of 20 to 40 feet. The average diameter of these trees approximately a foot and a half. There are seasonal draughts in which the trees loose their leaves.

Tropical Scrub and Thorn Forests

In the Tropical Scrub and Thorn Forests there is a distinct dry season. During this season, the trees loose their leaves and very little plant life exists on the ground, except for a few tufted plants. These plants are found in bunches. Most of the plants that exist in this area bear thorns. Due to this dry environment, fires occur with a high frequency.

Tropical Savannas

Tropical Savannas are found within the tropical zones of South America and Africa. They are characterized by broad grassy meadows with trees widely spaced. The soil is often red with trees that appear to be stunted in growth.

Saltwater Swamps

Saltwater Swamps are located in West Africa, Malaysia, the Pacific islands, Central and South America and India.

These areas are common in coastal areas prone to tidal flooding. Saltwater Swamps produce trees, which can reach a height of nearly 40 feet. Visibility is limited, and travel is difficult. Though many channels may be suitable for rafting, large amounts of travel afoot will be required.

The environment of the saltwater swamp is conducive to leeches, insects, crocodiles, caimans and many other life forms.

Freshwater Swamps

Freshwater Swamps are found inland in low-lying areas. Large volumes of thorny undergrowth, reeds, grasses and small palms characterize the plant life. These plants are dense, therefore, visibility is reduced to a minimum, and travel may be difficult.

pant. If a flotation means other than a life preserver is used, it must be readily removable from the airplane.

(2) Enough approved life rafts (with proper buoyancy) to carry all occupants of the airplane, and at least the following equipment for each raft clearly marked for easy identification

-
- (i) One canopy (for sail, sunshade, or rain catcher);
- (ii) One radar reflector (or similar device);
- (iii) One life raft repair kit;
- (iv) One bailing bucket;
- (v) One signaling mirror;
- (vi) One police whistle;
- (vii) One raft knife;
- (viii) One CO₂ bottle for emergency inflation;
- (ix) One inflation pump;
- (x) Two oars;
- (xi) One 75-foot retaining line;
- (xii) One magnetic compass;
- (xiii) One dye marker;
- (xiv) One flashlight having at least two size "D" cells or equivalent;
- (xv) At least one approved pyrotechnic signaling device;
- (xvi) A 2-day supply of emergency food rations supplying at least 1,000 calories a day for each person;
- (xvii) One sea water desalting kit for each two persons that raft is rated to carry, or two pints of water for each person the raft is rated to carry;

(2) Enough life rafts (each equipped with an approved survivor locator light) of a rated capacity and buoyancy to accommodate the occupants of the airplane. Unless excess rafts of enough capacity are provided, the buoyancy and seating capacity of the rafts must accommodate all occupants of the airplane in the event of a loss of one raft of the largest rated capacity.

(3) At least one pyrotechnic signaling device for each life raft.

(4) An approved survival type emergency locator transmitter. Batteries used in this transmitter must be replaced (or recharged, if the battery is rechargeable) when the transmitter has been in use for more than 1 cumulative hour, or when 50 percent of their useful life (or for rechargeable batteries, 50 percent of their useful life of charge) has expired, as established by the transmitter manufacturer under its approval. The new expiration date for replacing (or recharging) the battery must be legibly marked on the outside of the transmitter. The battery useful life (or useful life of charge) requirements of this paragraph do not apply to batteries (such as water activated batteries) that are essentially unaffected during probable storage intervals.

(b) The required life rafts, life preservers, and survival type emergency locator transmitter must be easily accessible in the event of a ditching without appreciable time for preparatory procedures. This equipment must be installed in conspicuously marked, approved locations.

(c) A survival kit, appropriately equipped for the route to be flown, must be attached to each required life raft.

125.209 Emergency equipment: Extended overwater operations.

(a) No person may operate an airplane in extended overwater operations unless it carries, installed in conspicuously marked locations easily accessible to the occupants if a ditching occurs, the following equipment:

(1) An approved life preserver equipped with an approved survivor locator light, or an approved flotation means, for each occupant of the aircraft. The life preserver or other flotation means must be easily accessible to each seated occu-

Survival in the Tropics

The most common medical problems experienced in a tropical environment are a result of infections and those caused by insect bites. If you sustained any injuries during a forced landing, those injuries must be treated immediately and given constant attention. Because of the warm, moist environment, the slightest scratch may become infected. All open wounds must be frequently cleansed and covered.

Insects are to the tropics as sand is to the desert. Insects thrive in the tropical environment. Many insects carry diseases and parasites. Mosquitoes, especially the anopheles variety, can carry malaria.

Malaria is compounded by people, and thus is more prevalent in populated areas. Even though you may not be in a highly populated area you should still take precautions from mosquitoes. Mosquitoes tend to be most prevalent during the early evening hours as well as hours just before dawn.

Malaria Prevention

- Dapsone and chloroquineprimaquine
- Insect Repellent
- Clothing which covers as much of the body as possible
- Nets and/or screens whenever possible
- Avoid area of likely infestation

Along with the risk of malaria, one must deal with the aggravation, and the danger of the dreaded mosquito bite. Scratching at the surface of the skin where the bite exists may cause an abrasion. There is a high possibility that this abrasion, exposed to the jungle's environment, could become infected. You should take measures to prevent, or lesson the effects of itching by applying an anti-itch ointment. If you do not have any products that provide relief from the itching you can try applying mud packs to the mosquito's bite.

Ticks are also common in the tropics. It's important to routinely examine your clothing, skin, and scalp. If a tick is found attached to your skin, cover it with some type of irritant. By applying a drop, or two, of kerosene, alcohol, or iodine you may persuade a tick to detach itself from the skin. A cigarette or burning stick, placed directly on the tick's body may also work. As soon as the tick is removed, wash the area thoroughly.

If fleas are prevalent, keep your pant legs tucked into your socks. Tropical fleas can burrow under your toenails and lay their eggs. Tropical flies lay eggs in open wounds, which is another reason to keep wounds clean and

sterilized. You can also cover them with a petroleum gel, which may cause the tick to detach.

Leeches are prevalent in the jungles of Southeast Asia, as well as the Southwest Pacific, and the Malay Peninsula. They are usually located in areas of stagnant water. They are generally found in swampy areas, streams, and moist jungle country. The leech is not poisonous; however, the abrasion left from its bite may become infected when exposed to the jungle environment.

If you locate a leech on yourself you should not try to immediately brush it off. The desirable method is to get the leech to release on its own. There are several suggested methods that may help to hasten the leech's release. The suggested methods include touching the leech with:

1. Insect repellent.
2. A moist piece of tobacco
3. The burning end of a cigarette
4. A coal from a burning fire.
5. A few drops of alcohol.

You can increase your chances of avoiding leeches all together by avoiding the areas in which they are most likely to exist. If this is not possible you can blouse your pants around the ankle area to prevent the leeches from finding their way up your legs and into the crotch area. If you have no way of blousing your pants you may tuck your pant legs into your boots, or socks.

You are more likely to encounter snakebites in the remote areas of Texas and New Mexico than in the jungle. You will likely encounter very few snakes, however, if you do encounter one, avoid it. Just as in any other environment, the best way to avoid snakebites in the jungle is by avoiding them. This means you should not attempt to provoke or handle any snake. Most bites occur when a snake feels threatened or startled, meaning most bites occur when humans are not paying attention to where they are stepping. When traveling you should always be alert to where you are stepping.

High humidity is associated with tropical regions; therefore, your clothing may remain damp or wet. Try to stay as dry as possible, especially before bedding down for the night. A good shelter or poncho will aid in this task. Staying dry is important in preventing skin disease.

You must begin early because it will become dark more quickly due to the dense canopy of foliage above. When it is time to rest and sleep, you will need to construct a shelter. The following are suggestions to keep in mind when building your shelter:

1. Construct your shelter on a high point such as a knoll.

(b) No person may takeoff an airplane for a flight over water more than 30 minutes flying time or 100 nautical miles from the nearest shore unless it has on board the following survival equipment:

- (1) A life preserver, equipped with an approved survivor locator light, for each occupant of the airplane.
- (2) Enough life rafts (each equipped with an approved survival locator light) of a rated capacity and buoyancy to accommodate the occupants of the airplane.
- (3) At least one pyrotechnic signaling device for each life raft.
- (4) One self-buoyant, water resistant, portable emergency radio-signaling device that is capable of transmission on the appropriate emergency frequency or frequencies and not dependent upon the airplane power supply.
- (5) A lifeline stored in accordance with 25.1411(g) of this chapter.

(c) The required life rafts, life preservers, and signaling devices must be installed in conspicuously marked locations and easily accessible in the event of a ditching without appreciable time for preparatory procedures.

(d) A survival kit, appropriately equipped for the route to be flown, must be attached to each required life raft.

(e) As used in this section, the term shore means that area of the land adjacent to the water which is above the high water mark and excludes land areas which are intermittently under water.

121.339 Emergency equipment for extended overwater operations.

(a) Except where the Administrator, by amending the operations specifications of the certificate holder, requires the carriage of all or any specific items of the equipment listed below for any overwater operation, or upon application of the certificate holder, the Administrator allows deviation for a particular extended overwater operation, no person may operate an airplane in extended overwater operations without having on the airplane the following equipment:

- (1) A life preserver equipped with an approved survivor locator light, for each occupant of the airplane.

(1) Unless excess rafts of enough capacity are provided, the buoyancy and seating capacity beyond the rated capacity of the rafts must accommodate all occupants of the airplane in the event of a loss of one raft of the largest rated capacity; and

(2) Each raft must have a trailing line, and must have a static line designed to hold the raft near the airplane but to release it if the airplane becomes totally submerged.

(c) Approved survival equipment must be attached to each life raft.

(d) There must be an approved survival type emergency locator transmitter for use in one life raft.

29.1415 Ditching equipment.

(a) Emergency flotation and signaling equipment required by any operating rule of this chapter must meet the requirements of this section.

(b) Each life raft and each life preserver must be approved. In addition-

(1) Provide not less than two rafts, of an approximately equal rated capacity and buoyancy to accommodate the occupants of the rotorcraft; and

(2) Each raft must have a trailing line, and must have a static line designed to hold the raft near the rotorcraft but to release it if the rotorcraft becomes totally submerged.

(c) Approved survival equipment must be attached to each life raft.

(d) There must be an approved survival type emergency locator transmitter for use in one life raft.

91.509 Survival equipment for overwater operations.

(a) No person may takeoff an airplane for a flight over water more than 50 nautical miles from the nearest shore unless that airplane is equipped with a life preserver or an approved flotation means for each occupant of the airplane.

2. Make sure it is in an open area and well away from water (The ground should be dryer there with fewer crawling insects.)
3. To avoid insects, design your sleeping area so that it is off the ground. Piling up several layers of palm fronds or other broad leaves works well.
4. Constructing an elevated A-Frame may make a better bed. Place your sleeping platform off the ground.
5. Cover the top with four or five layers of long, spineless palm leaves.
6. Pieces of bark or mats of grass will help to waterproof the shelter.

Because of the heat and humidity in the tropics, you will find that the simplest tasks will drain your energy. You will need large amounts of rest and sleep to recover. Again, start your shelter construction well before dark.

A fire in the tropics is most desirable. It will keep you warm and comfortable during the night. As well as protect you from mosquitoes, flies, and curious animals. A roaring fire is not necessary. A small fire will serve the purpose and will be easier to maintain.

Fuel for a fire is plentiful, though most of it may be damp. To find dry tinder, try the inner layers of bark. Fibers in the base of palm leaves also make good tinder. Once you have a good, hot fire going, you can add damp wood.

Signaling in the tropics poses a few more difficulties than normal. Surface-to-air signals, such as reflectors and rescue codes, may be ineffective because of the thick foliage overhead. Flares and launchers are also not as effective in such situations. To ensure effective signaling, these and other such devices need to be used out in the open. This may require you to travel some distance. However, unless you know where you are and where you are heading, don't chance it and stay at your present location.

If your aircraft were to go down there will likely be some telltale signs for rescuers. Scattered debris of the aircraft, bent or broken tree limbs, or severed tree tops. Also, the aircraft's emergency locator transmitter (or E.L.T.) should be on and transmitting. These signs will help rescuers locate the aircraft. Therefore, stay near the wreckage.

Finding water should be an easy task. But be sure to purify all water from streams and surfaces before consumption. Water from precipitation is good and safe to drink. You can also drink water from plants without purifying it. Many vines, if cut, will drip a steady stream of water.

A banana plant cut down to a one-foot-tall trunk is an excellent water source. After cutting it down, hollow out the trunk to form a deep bowl. In a few hours, the bowl will overflow with water. The bowl will produce water for

about four days. Cover it to protect it from insects. One word of caution: If the surface of the water becomes covered with a blue-tinted film, skim-off as much of the film as possible, as drinking the film may make you sick.

The tropics are a virtual farmer's market filled with delicious fruits for you to eat. Papaya is abundant. Some papaya may get up to five pounds in weight. The tropical star apple is also there for your consumption. Wild pineapple can also be found and eaten raw, but you may consider cooking it. Too much raw pineapple can cause stomach discomfort. Roots and bulbs such as taro, cassava, and wild yams are abundant and nutritious. Coconuts are also a potential source of sustenance. The coconut's meat, milk, and flowers can be safely eaten. In the tropics, keep in mind, there is an abundance of fruits and vegetables that are safe to eat.

Concerning meat in the tropics, fish and land crabs are probably the easiest meat source. However, make sure that the crabs and fish are thoroughly cooked.

Survival in the tropics can be like paradise, or it can be like purgatory. You can live off what the environment provides by using knowledge, common sense, and your innate desire to survive. By becoming knowledgeable and being prepared, you should return home safely with some interesting stories to share.

Choose a raft that you are comfortable with and that meets all of your personal requirements. Keep in mind that you will have to lift it out of the aircraft when it comes time to use it. For this reason you should choose a raft that is light enough so that most who fly with you can lift it.

If you determine that it is not feasible to buy a raft there are various FBOs in the coastal regions that rent rafts. An average cost for a four to six person raft is around \$17 a day; a 9 to 13-person raft; around \$25 a day. Some FBOs rent life preservers for roughly \$5 a day. Some FBOs sell life preservers for around \$50. If you seldom travel over water renting might be the best choice for you. However, if you do rent you should ask the FBO to familiarize you with the equipment and its proper use.

The following are FAR's referencing rafts & equipment and their requirements pertaining to life rafts.

Federal Air Regulations (FARs) Pertaining to Life Rafts

23.1415 Ditching equipment.

- (a) Emergency flotation and signaling equipment required by any operating rule in this chapter must be installed so that it is readily available to the crew and passengers.
- (b) Each raft and each life preserver must be approved.
- (c) Each raft released automatically or by the pilot must be attached to the airplane by a line to keep it alongside the airplane. This line must be weak enough to break before submerging the empty raft to which it is attached.
- (d) Each signaling device required by any operating rule in this chapter, must be accessible, function satisfactorily, and must be free of any hazard in its operation.

25.1415 Ditching equipment.

- (a) Ditching equipment used in airplanes to be certificated for ditching under . 25.801, and required by the operating rules of this chapter, must meet the requirements of this section.
- (b) Each life raft and each life preserver must be approved. In addition -

choose a pack that fits your equipment proportionately and is easy and convenient to carry. You can find various packs at any outdoor store specializing in camping and hunting and at most department stores. Fanny packs work very well for PSKs because they are strapped on. This frees your hands to perform other tasks. It also provides you with the luxury of having your equipment with you at all time, without the hassle of having to carry it by hand every time you go somewhere.

One more question remains as far as packing a PSK: How many days should I prepare my kit for? Statistics show that nearly all survival situations last 72 hours or less. You can increase your chances of survival and decrease the length of time before rescue by filing a flight plan or letting someone know where you are going. Maybe you should consider this as part of your survival preparation.

RAFTS & ACCESSORIES

Although the PSK is a great item to have on all flights, it may not be the only piece of equipment you will need. If your flight takes you over vast stretches of open water, you might consider carrying some type of raft and/or life preservers. If you decide that you would like to purchase a raft for your aircraft, choose one that fits your needs, and not those of the salesperson.

When choosing a raft for your aircraft you must first determine what the maximum weight allowed would be for your raft. Most four to six person rafts range in weight from 40 to 70 pounds. You should then determine the number of people who, at any given time, might have to use the raft for survival. If you normally fly with just one passenger, but occasionally with three, you should have enough raft space for four persons.

It is true that any raft is better than no raft at all. However, if you are looking for ways to improve the quality of your raft, consider some of the following items when searching:

1. Canopy
2. Inflatable floor
3. Dual Cells
4. Boarding lights
5. Sea anchors
6. Accessory kit
7. Visible colors (florescent orange)
8. Rain catches (water procurement)
9. Life line (around outside of raft)
10. Heaving line

TROPICAL SURVIVAL **Chapter Quiz**

**1. Some jungle types can have unto this many layers forming its canopy:
(Circle the best answer)**

- a. 2
- b. 5
- c. 10
- d. 15

**2. All jungle types have dense vegetation growth on the ground:
(Circle the best answer)**

Yes

No

**3. These are found in coastal areas that are prone to tidal flooding:
(Circle the best answer)**

- a. Freshwater swamps
- b. Tropical rain forest
- c. Saltwater swamps
- d. Tropical savannas

**4. The two most immediate medical concerns in the tropics are:
(Circle the best answer)**

- a. Infections, and hangnails
- b. Diarrhea, and infection
- c. Dehydration, and disease from insects
- d. Infected wounds, an disease from insects

WATER SURVIVAL

Water covers more than 75% of the earth's surface. Even though mankind has mastered travel over these vast expanses of water, ditching your aircraft on the open sea will find you trying to survive one of the most inhospitable environments anywhere. It may be inhospitable but it is survivable. Not only survivable, it may be the best option if given a choice between ditching on land or water. It is important to keep in mind that a water ditching not only involves the ocean, but rivers and lakes as well. This chapter will discuss "wet ditching" procedures from pre-ditching through post-ditching.

STATISTICS

It is important to understand that ditching an aircraft in water is survivable. A study of General Aviation ditchings shows that nearly 92% of occupants were able to egress successfully and nearly 88% survived. The numbers go up to 95% for successful egress and nearly 90% for survivability when you exclude high-risk operations such as long distance ocean ferry flights. The numbers imply not only that ditchings are survivable, but also that proper training and equipment will improve ones chances of survival.

Statistics also prove that most ditchings, nearly 64%, occur near beaches, bays, gulfs, or islands. Only 12% occur in the "open sea" with 15% occurring on lakes and 7% on rivers. If presented with the choice of ditching on land or in the water, your best choice may be to put the aircraft down in a lake, river, or maybe near a beach.

If flying in a high-wing aircraft you can count on the aircraft flipping upon ditching, right? Not necessarily. In an article written by Doug Ritter, "**A Ditching Gone Awry**," <http://www.equipped.org/aopa-ditch-rebut.htm>, Mr. Ritter addresses the issue of whether high-wing aircraft are more likely to flip over upon impact with the water. He interviewed many survivors of aircraft ditchings, which took place over a five-year period. Of those interviewed, approximately half were flying fixed-gear high-wing aircraft. Only three reported flipping over and completing the water landing upside down, while all survived the experience.

WHEN DOES A SURVIVAL SITUATION BEGIN?

A water ditching is defined as an intentional water landing in which the aircraft touches down under control. An important fact to remember is that a survival situation

deciding on equipment for your PSK, you should also keep these priorities in mind. The priorities may change according to the situation, but for the most part, they will be as follows:

- First Aid
- Shelter
- Water
- Food
- Signaling

By following these priorities as a guideline for choosing equipment for your kit, you ensure that those items that you choose will immediately provide for your personal needs.

Identify your flying environment. After you have established the priorities, you need to define the environment that you will be flying over. Since the environments) that you fly over may consist of various climates and terrain, you should prepare for the worst. This means that if you take off from Los Angeles and are planning to fly over the Rockies, you should not dress down to the comfort level in L.A. You should wear appropriate clothing, or have them readily accessible, for the cold temperatures you might be facing if stranded over-night in the Rockies. You can always take clothing off if need be but you have to have the clothing with you to add layers.

Determine which items will be beneficial to you. The items you choose for your PSK should cover the priorities listed above. There should be at least a minimal first-aid kit, some form of shelter from the elements, water procuring items and purifier, and some form of signaling device. Food was not mentioned because you could survive as many as 30 days without it, while most survival situations involving aviation last less than 72 hr.'s. However, if you have room left after packing your other items, then by all means provide some high caloric food, as it will provide comfort to you.

Since it is a personal survival kit you might also find it beneficial to provide items that might meet your specific needs. These items could include a couple days supply of a prescription medication, even an extra set of eye-glasses and/or eyeglass repair kit. You should also pick items that can serve dual functions. An example of this would be the use of trash bags for collecting garbage, but might also be used as an immediate shelter or even a solar still. Plastic being used to build a solar still should be clear.

A list of suggested PSK items has been provided on the following page. Most of the items listed can be found at local department stores or stores dealing with camping, hunting, and fishing equipment.

Choose an appropriate pack for the equipment chosen. You should

KITS, RAFTS, and ACCESSORIES

Every year countless people die because they were not prepared for the environment in which they were vacationing, hiking, working, or just passing through. It is heartbreaking to think that some of these deaths could have been prevented with just a little planning for the environment or environmental changes that may take place. Imagine a pilot who takes off from Las Vegas, Nevada at 12:00 p.m. Pacific Time, temperature at 78° F, enroute to Omaha, NE. While over the Rocky Mountains at around 7:00 p.m. (Mountain Time), temperature dropping below 40° F, he/she loses power and manages to land the aircraft with minimal injury to himself/herself and a passenger. Due to poor planning, however, they are both in short-sleeve shirts and do not have any survival equipment on the aircraft. Within hours, they both succumb to exposure. Another scenario could find the pilot and passengers) surviving a ditching in the Pacific ocean and due to the lack of life preservers and/or rafts, some or all of the group perishes within hours, even minutes. This chapter will introduce you to the make-up and preparation requirements of the Personal Survival Kit (**PSK**), as well as inform you about various life rafts and life preservers that are available to the general aviation community.

PERSONAL SURVIVAL KITS

The PSK is defined as any equipment you carry on the aircraft for the specific intention of utilizing if you are forced into a survival situation. If you choose only to carry a knife in your pocket, it can be considered your PSK. A PSK should be small enough so that it can easily be carried or attached to you when exiting the aircraft.

Why pack a PSK if you already have survival gear in the back of the aircraft? Every survival situation poses a multitude of different challenges, but keep in mind that you might have to exit the aircraft swiftly and the only items that will leave the aircraft with you are those that you are wearing or are readily accessible on the way out.

When deciding how to put a PSK together, you should:

1. Define your priorities.
2. Identify your flying environment.
3. Decide on items, which you see as beneficial.
4. Choose an appropriate pack for the equipment chosen.

Define priorities. In every survival situation, there will be priorities. These priorities were mentioned earlier in the "will to survive" chapter. When

begins at the same time as an in-flight emergency. Once it is apparent that ditching is a possibility, you are in a survival mode. The main objectives are to notify as many people of your situation and location as possible and to get the aircraft safely into the water with as little damage as possible. Each crewmember will have specific tasks to perform. Use a checklist to ensure that all tasks are completed. Also, a checklist will help everyone to think and act in a rational and logical manner.

The following was taken from the chapter six of the Aeronautical Information Manual, "Emergency Procedures," effective February 19, 2004.

6-3-1. Distress and Urgency Communications

a. A pilot who encounters a *distress* or *urgency* condition can obtain assistance simply by contacting the air traffic facility or other agency in whose area of responsibility the aircraft is operating, stating the nature of the difficulty, pilot's intentions and assistance desired. *Distress* and *urgency* communications procedures are prescribed by the International Civil Aviation Organization (ICAO), however, and have decided advantages over the informal procedure described above.

b. *Distress* and *urgency* communications procedures discussed in the following paragraphs relate to the use of air ground voice communications.

c. The initial communication, and if considered necessary, any subsequent transmissions by an aircraft in *distress* should begin with the signal MAYDAY, preferably repeated three times. The signal PAN-PAN should be used in the same manner for an *urgency* condition.

d. *Distress* communications have absolute priority over all other communications, and the word MAYDAY commands radio si-

lence on the frequency in use. *Urgency* communications have priority over all other communications except *distress*, and the word PAN-PAN warns other stations not to interfere with *urgency* transmissions.

e. Normally, the station addressed will be the air traffic facility or other agency providing air traffic services, on the frequency in use at the time. If the pilot is not communicating and receiving services, the station to be called will normally be the air traffic facility or other agency in whose area of responsibility the aircraft is operating, on the appropriate assigned frequency. If the station addressed does not respond, or if time or the situation dictates, the *distress* or *urgency* message may be broadcast, or a collect call may be used, addressing "Any Station (Tower) (Radio) (Radar)."

f. The station addressed should immediately acknowledge a *distress* or *urgency* message, provide assistance, coordinate and direct the activities of assisting facilities, and alert the appropriate search and rescue coordinator if warranted. Responsibility will be transferred to another station only if better handling will result.

g. All other stations, aircraft and ground, will continue to listen until it is evident that assistance is being provided. If any station becomes aware that the station being called either has not received a *distress* or *urgency* message, or cannot communicate with the air-

SEA SURVIVAL
Chapter Quiz

1. The survival situation begins:
(Circle the best answer)

- a. When you reach the ground and are out of the aircraft
- b. When you finish rendering First Aid
- c. After all equipment has been inventoried
- d. At the same time as an in-flight emergency begins

2. At what point of the ditching should you unstrap from your seat?
(Circle the best answer)

- a. After first impact
- b. Before any impact
- c. After aircraft comes to complete stop
- d. After second impact

3. What one medical problem will most likely be present in all survivors after an aircraft accident?
(Circle the best answer)

- a. Shock
- b. Hypothermia
- c. Dehydration
- d. No significant problems

4. Swimming cools the body _____% faster than just staying still in water.
(Circle the best answer)

- a. 15
- b. 25
- c. 35
- d. 50
- e. Swimming will warm you up

5. The use of this will give adequate protection against cold water and also promote buoyancy.
(Circle the best answer)

- a. Trash bags
- b. Extra clothing
- c. An exposure suit
- d. None of the above



COWFISH
(6-12 In.)

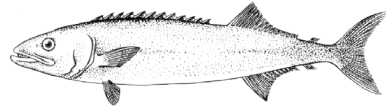

OIL FISH
(3-5 Ft.)

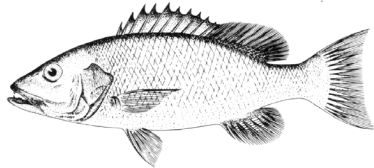

REDSNAPPER FISH
(2-3 Ft.)

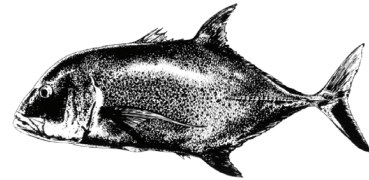

JACKFISH
(About 2 Ft.)

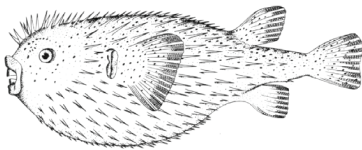

PORCUPINE FISH
(About 1 Ft.)

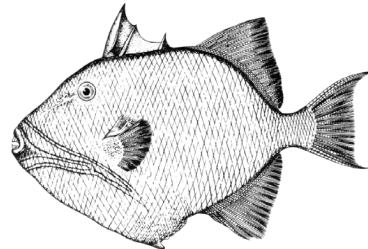

TRIGGER FISH
(1-2 Ft.)

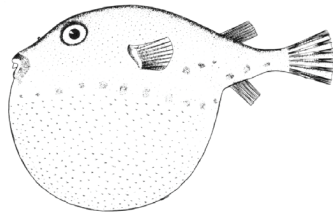

PUFFER FISH
(10-15 In.)

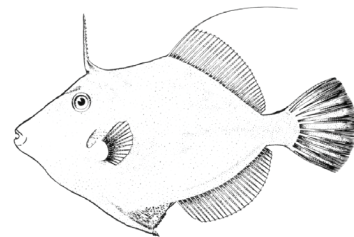

THORNFISH
(About 1 Ft.)

7-6 con't Venomous Spine Fish USAF Reg. 64-4

craft in difficulty, it will attempt to contact the aircraft and provide assistance.

h. Although the frequency in use or other frequencies assigned by ATC are preferable, the following emergency frequencies can be used for distress or urgency communications, if necessary or desirable:

1. **121.5 MHz and 243.0 MHz.** Both have a range generally limited to line of sight. 121.5 MHz is guarded by direction finding stations and some military and civil aircraft. 243.0 MHz is guarded by military aircraft. Both 121.5 MHz and 243.0 MHz are guarded by military towers, most civil towers, FSSs, and radar facilities. Normally ARTCC emergency frequency capability does not extend to radar coverage limits. If an ARTCC does not respond when called on 121.5 MHz or 243.0 MHz, call the nearest tower or FSS.

2. **2182 kHz.** The range is generally less than 300 miles for the average aircraft installation. It can be used to request assistance from stations in the maritime service. 2182 kHz is guarded by major radio stations serving Coast Guard Rescue Coordination Centers, and Coast Guard units along the sea coasts of the U.S. and shores of the Great Lakes. The call "Coast Guard" will alert all Coast Guard Radio Stations within range. 2182 kHz is also guarded by most commercial coast stations and some ships and boats.

6-3-2. Obtaining Emergency Assistance

a. A pilot in any *distress* or *urgency* condition should *immediately* take the following action, not necessarily in the order listed, to obtain assistance:

1. Climb, if possible, for improved communications, and better radar and direction finding detection. However, it must be understood that unauthorized climb or descent under IFR conditions within controlled airspace is prohibited, except as permitted by 14 CFR Section 91.3(b).

2. If equipped with a radar beacon transponder (civil) or IFF/SIF (military):

(a) Continue squawking assigned Mode A/3 discrete code/VFR code and Mode C altitude encoding when in radio contact with an air traffic facility or other agency providing air traffic services, unless instructed to do otherwise.

(b) If unable to immediately establish communications with an air traffic facility/agency, squawk Mode A/3, Code 7700/Emergency and Mode C.

3. Transmit a *distress* or *urgency* message consisting of *as many* as necessary of the following elements, preferably in the order listed:

(a) If *distress*, MAYDAY, MAYDAY, MAY-DAY; if *urgency*, PAN-PAN, PAN-PAN, PAN-PAN.

rents as transportation and float just under the surface. Watch for and avoid them. To avoid hazardous marine life, take the following precautions:

- Do not splash water around raft (*could attract sharks*)
- Throw all body waste far from raft
- Keep feet and hands in raft
- Try to keep all blood and wounds out of water
- Keep clothing on
- Do not fish if sharks are seen in area
- Stay in raft at all times

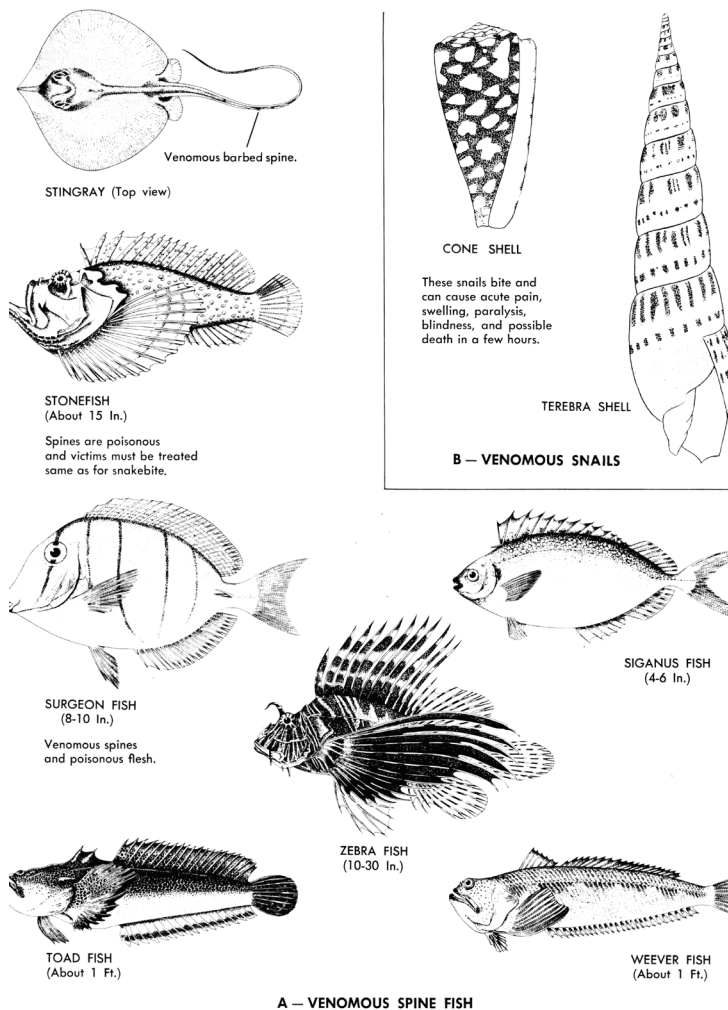

is rainwater. Keep a lookout for rain showers. Have rain catches ready for quick use.

The FAA has placed aboard its rafts a reverse osmosis pump. Pumping this device continuously will allow a person to filter out salt and all other contaminants from water leaving behind purified drinking water. If this device were pumped for 24 hours continuously (*at one stroke per second*), it would produce about 6 gallons of drinking water. This production would alleviate any water needs as long as you are physically able to work the device.

- **Food:** The Sea has the greatest source of food on the face of the earth. Do not consume any food unless there is ample drinking water. The primary food source of the sea is, of course, fish. Fish from the ocean can be eaten raw. Most all fish are edible, although, there is a few whose flesh is considered poisonous to man. A good rule of thumb to follow is, if it looks like a typical fish, it is probably safe to consume.

Avoid the following types of fish:

- Fish that are brightly colored
- Fish with bristles or spines
- Fish that puff up
- Fish with beak-like lips

If you make it to land, shellfish are a good food source and may be eaten raw or cooked. Be sure to eat only fresh shellfish as they spoil quickly once removed from water.

Hazardous marine life in the ocean is more a psychological threat than a physical one. Apprehension of "what is down there" stems chiefly from fear of the unknown.

- **Sharks:** A shark's primary role in the oceanic food chain is that of a scavenger. There are 300 or more species of sharks in the world's oceans, and of this number, only about 9 are considered a threat to man. Chances are, you will probably never see a shark. Concentrate your mental energies on something more productive, such as rescue.

- **Sea Snake:** Sea snakes surface about every 20 to 30 minutes. If you spot one you should not try to capture, or provoke it, as they are extremely poisonous.

- **Jellyfish and the Portuguese Man of War:** These invertebrates have a bulbous-shaped body and long tentacles that sometimes can be 100 feet in length. The tentacles have stinging cells used to stun small fish. If a person comes in contact with its tentacles, it can deliver a painful sting. Both use cur-

(b) Name of station addressed.

(c) Aircraft identification and type.

(d) Nature of *distress* or *urgency*.

(e) Weather.

(f) Pilots intentions and request.

(g) Present position, and heading; or if *lost*, last known position, time, and heading since that position.

(h) Altitude or flight level.

(i) Fuel remaining in minutes.

(j) Number of people on board.

(k) Any other useful information.

REFERENCE-

Pilot/Controller Glossary Term- Fuel Remaining.

b. After establishing radio contact, comply with advice and instructions received. Cooperate. Do not hesitate to ask questions or clarify instructions when you do not understand or if you cannot comply with clearance. Assist the ground station to control communications on the frequency in use. Silence interfering radio stations. Do not change frequency or change to another ground station unless absolutely necessary. If you do, advise the ground station of the new frequency and station name prior to the change, transmitting in the blind if necessary. If two-way communications cannot be established on the new frequency, return immediately to the fre-

quency or station where two-way communications last existed.

c. When in a distress condition with bailout, crash landing or ditching imminent, take the following additional actions to assist search and rescue units:

1. Time and circumstances permitting, transmit as many as necessary of the message elements in subparagraph a3 above, and any of the following that you think might be helpful:

- (a) ELT status.
- (b) Visible landmarks.
- (c) Aircraft color.
- (d) Number of persons on board.
- (e) Emergency equipment on board.

2. Actuate your ELT if the installation permits.

3. For bailout, and for crash landing or ditching if risk of fire is not a consideration, set your radio for continuous transmission.

4. If it becomes necessary to ditch, make every effort to ditch near a surface vessel. If time permits, an FAA facility should be able to get the position of the nearest commercial or Coast Guard vessel from a Coast Guard Rescue Coordination Center.

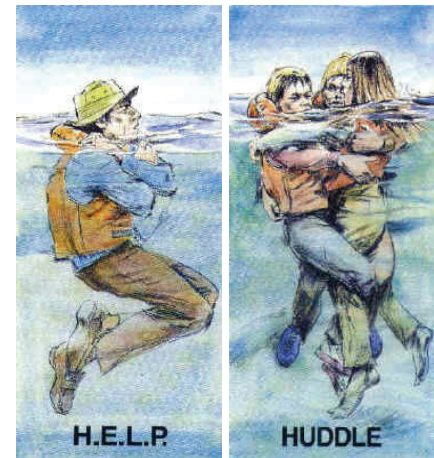

7-4 HELP AND HUDDLE POSITIONS. Illustration taken from the Search and Rescue Society of British Columbia Address: <http://www.islandnet.com/sarbc/resqair/help-hud.html>

An exposure Suit gives adequate protection against cold water and promotes buoyancy. There is a variety of exposure suits on the market; you should find one that meets your specific needs.



7-5 Photo of exposure suits

"In a matter of minutes the Cloverleaf rolled over and sank off the Alaskan coast. I floated in 37-degree water for 27 hours without a life raft. The Bayley Exposure Suit saved my life, without it I had no chance for survival."

Captain R.T. Laws

- **Dehydration:** "Water, water everywhere but not a drop to drink." This old saying still holds true today. Finding drinking water, to fight dehydration while stranded at sea, will be a challenge. You will find packaged water in the survival kits, but not in great quantities. The primary thing to remember is that you should ration your sweat, not your water. If there is water, drink it. It's better to have it in the body where it's doing some good. The temptation to drink seawater could be a lethal one. Seawater is no substitute for drinking water. When you drink seawater, you also consume large amounts of salt, which will eventually poison cells. The only safe substitute for drinking water

coming incapacitated. As a rule, if water temperature is 50 degrees or below and you have a flotation aid, don't swim. Go into a fetal position and conserve body heat. If the raft is 100 feet or so from you, should you swim for it? Common sense would say yes, however, this is going to be a judgment call. By staying still in cold water, your body will transmit heat to a layer of water surrounding the skin. This will reduce the amount of heat lost to cool water passing over the skin.

Situation	Predicted Survival Time (Hours)
Situation No Flotation	
Drown-Proofing	1.5
Treading Water	2.0
With Flotation	
Swimming	2.0
Holding Still	2.7
HELP	4.0
Huddle	4.0

7-3 EXPECTED SURVIVAL TIME IN 50° WATER. Information located at the Washington State Parks and Recreation Commission Boating Programs website. Address: <http://www.boatwashington.org/hypothermia.ht>

While wearing a personal flotation device, you will be able to float while expending minimal energy. Wearing a flotation device will also afford you the opportunity to assume the Heat Eliminating Lessening Position (HELP). This position, sometimes referred to as the fetal position, helps to reduce the amount of heat loss while protecting those areas most susceptible to heat loss. These areas include the armpits, sides of the chest, groin, and the back of the knees. If several persons are in the water, they can huddle together and use one another to transfer, and maintain, ones body core temperature.

5. After a crash landing, unless you have good reason to believe that you will not be located by search aircraft or ground teams, it is best to remain with your aircraft and prepare means for signaling search aircraft.

6-3-3. Ditching Procedures

FIG 6-3-1

Single Swell (15 knot wind)

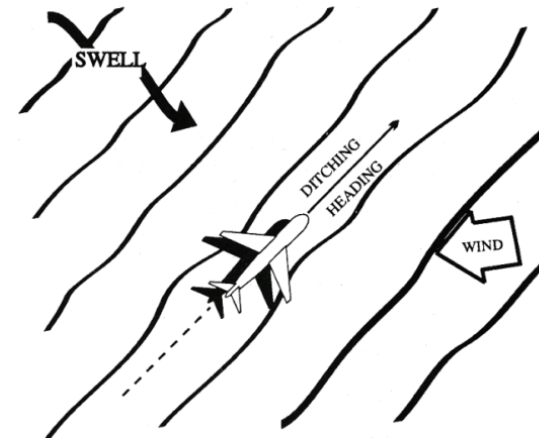

socks for long periods; use body heat to dry them. Promote good circulation in feet by wiggling toes and ankles. Do not wear tight-fitting shoes.

Hypothermia: Hypothermia is covered in detail in the chapter on Cold Land Survival.

Immersion Hypothermia: Hypothermia is the cooling of the body's core. In immersion hypothermia, the rate of cooling is greatly accelerated. In cold water, the skin and peripheral areas cool very rapidly because of increased body area in contact with the cold. Seawater freezes at 28 - 29 degrees F.; water near icebergs is usually this cold. A person who comes in contact with water at such temperatures goes into an immediate form of shock. Upon submersion, smaller blood vessels and capillaries contract, causing the blood pressure and heart rate to increase. The victim would be unconscious in 7 minutes and could die in 20. Many factors affect survival time in cold water: age, body size, energy levels, and type of clothing all influence survival time to some degree. Table 7-1 shows times that were established by the University of Victoria, British Columbia. Subjects were wearing life jackets and light clothing while remaining motionless.

FIG 6-3-2

Double Swell (15 knot wind)

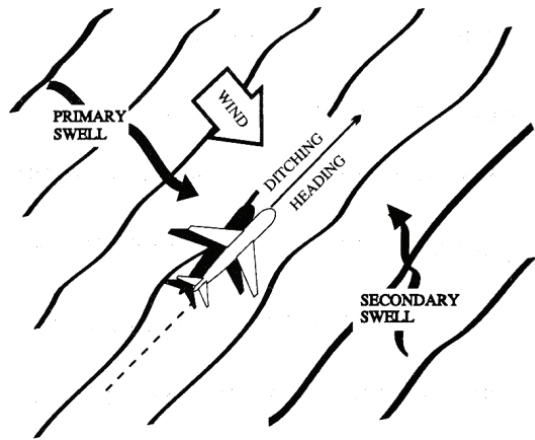
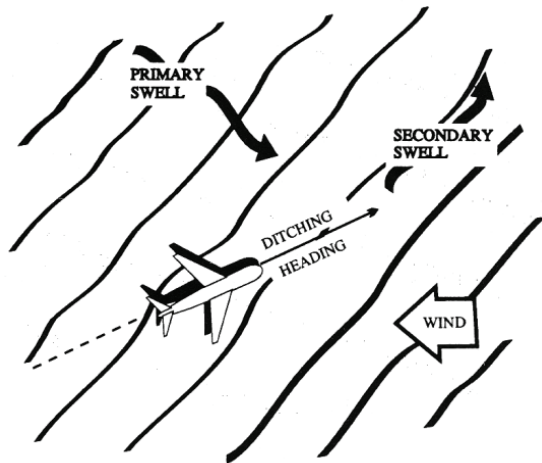

FIG 6-3-3

Double Swell (30 knot wind)



<u>WATER TEMPERATURE(F)</u>	<u>SURVIVAL TIME</u>
32	15 Min
36.5	30 Min
41	60 Min
50	3 Hrs
59	7 Hrs
68	16 Hrs
77	3 Days or more

7-2 WATER TEMPERATURE AND SURVIVAL TIMES. Information taken from "SURVIVAL SENSE FOR PILOTS," Robert Stoffel and Patrick La Valla, 1990

Swimming would seem to be the best way to keep warm in the water, but this is not the case. As a person swims, circulation increases in arms and legs, bringing the blood in contact with cooler water. This cooler water is continuously being dumped over the body, accelerating hypothermia. Studies have shown that swimming cools the body 35% faster than just staying still. The average person can swim about .85 miles in 50-degree water before be-

sea and stabilize the raft.)

- Dry raft using bailing bucket and sponge.
- Check sea anchor for proper release. Sea anchor will reduce drift and increase stability. Length of line should be adjusted according to the nature of the seas. Keep the sea anchor line long; adjust its length so that when the raft is at the crest of a wave, the sea anchor will remain in the trough.
- Keep survivors distributed evenly and low in the raft.
- Secure and adjust canopy according to sea conditions and climate.
- Activate the ELT.
- Retrieve reverses osmosis pump. (*For fresh drinking water*)
- Inventory all survival equipment from the MOD-1 and the raft accessory kit.
- Rescue. Don't consider yourself rescued until the rescue vehicle reaches dry land

Medical problems that arise due to sea survival can be debilitating and life threatening. These problems should be treated as soon as they arise:

Shock: After the initial chaos and ditching, all survivors may suffer from shock. Once in the raft, it is important to keep everybody as warm as possible, without overheating. By erecting the canopy and raising the spray shields, the temperature will increase quickly. Some will suffer from shock more than others. Look for pale and cool skin. Shock victims may be sweaty and breathing rapidly. Their pulse will be weak and rapid. They may act dazed or be unconscious. If you notice any of the symptoms, suspect shock and treat for it. Lay the victims flat, with feet raised, and keep them warm with solar blankets, extra clothing, and body heat.

Salt Water Sores: These sores are produced by the constant rocking and chafing with the raft in a salt-water environment. These sores have a blister like appearance and feel like a mild burn. Do not open the sores or squeeze them. Apply an antiseptic and keep them dry.

Dark Urine and Constipation: These conditions are common among people in a survival situation. These are simply ways your body copes with stress in a short-term. In the long-term, it is probably due to dehydration. When water is finally obtained, this will clear up by itself. Do not give laxatives for constipation, as this will hasten dehydration.

Immersion Foot (Trench Foot): Immersion foot is an injury caused by prolonged exposure to damp conditions. The feet will have a cracked and pruned appearance, and will be red, and then become pale in color. The foot will swell and become very sensitive. To prevent this problem, keep your raft and feet dry. As soon as your feet become wet, dry them. Never wear wet

FIG 6-3-4

(50 knot wind)

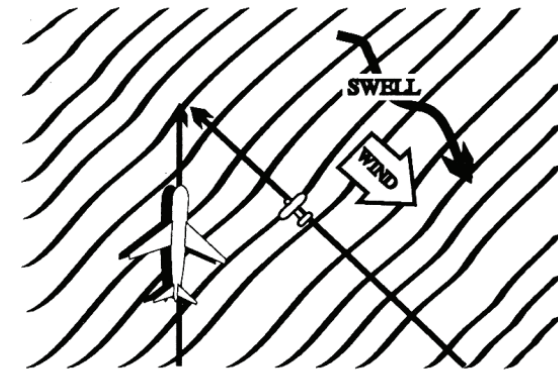

Aircraft with low landing speeds - land into the wind.

Aircraft with high landing speeds - choose compromise heading between wind and swell.

Both - land on back side of swell.

FIG 6-3-5

Wind-Swell-Ditch Heading

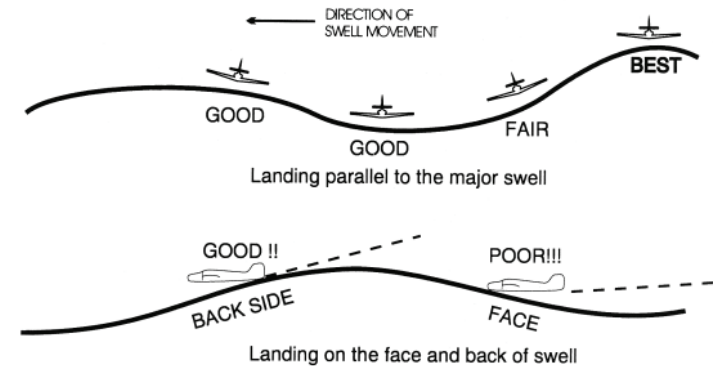

a. A successful aircraft ditching is dependent on three primary factors. In order of importance they are:

1. **Sea conditions and wind.**
2. **Type of aircraft.**
3. **Skill and technique of pilot.**

b. Common oceanographic terminology.

1. **Sea.** The condition of the surface that is the result of both waves and swells.
2. **Wave** (or Chop). The condition of the surface caused by the local winds.
3. **Swell.** The condition of the surface which has been caused by a distance disturbance.
4. **Swell Face.** The side of the swell toward the observer. The backside is the side away from the observer. These definitions apply regardless of the direction of swell movement.
5. **Primary Swell.** The swell system having the greatest height from trough to crest.
6. **Secondary Swells.** Those swell systems of less height than the primary swell.
7. **Fetch.** The distance the waves have been driven by a wind blowing in a constant direction, without obstruction.

Now, your other hand, still on the harness, can follow the harness down to the buckle and release. Once you have released the harness, you can move your hand over the the exit frame and proceed to pull yourself out. You should not attempt to kick your feet as if you were swimming. This may cause you to become entangled in the harness or, if others are on board, you may cause injury to other survivors. Simply pull yourself through the exit completely and push yourself away from the aircraft.

Once you have ensured that you are free of the aircraft you can inflate your lifevest, if applicable. While surfacing you should keep one hand above your head for protections.

It is important to note that if a buoyancy device aids your ascent you should make a conscience effort to exhale on the way up. If the aircraft was sinking when you took your final breath, it is remotely possible that the air may have been compressed. Likewise, it is very important that you exhale on ascent if you are breathing from any form of compressed air cylinder.

RAFT ACTIONS

Check all crewmembers and assist the injured. If time and conditions permit, gather as much survival equipment as you can. Next, locate the raft and get it out of the fuselage. After the raft is out, evacuate. The first person out of the fuselage should inflate the raft. Once the raft is inflated, pass the lanyard to the next person out, or have one person retain the lanyard till everyone is out and into the water or raft. You may opt to tether the lanyard to the aircraft since aircraft have been know to float for hours, even days, after ditching. If the fuselage goes under suddenly, you will not have to worry about cutting the lanyard. This is because the lanyard is designed to break away from the raft at a tensile strength of 500 lb.'s. Once in the water, get as far away from the fuselage as possible and board the raft. If the aircraft is still afloat, you can board directly into the raft. But, if it is doubtful that the fuselage will remain afloat for a period of time, get into the water and away from the fuselage. Remember to hold on to the tether line if you choose to enter the water. This will ensure that you remain in contact with the raft. Once in the raft, ensure that all crewmembers are present and assist the injured with boarding. Basic raft actions include:

- One individual assumes command. (*Usually the pilot in command in accordance with international law*)
- Retrieve accessory container tied to raft. (*Always keep tied to raft and closed after use*)
- Retrieve hand pump.
- Inspect buoyancy tubes for damage. If punctures are found, repair. Inflate as necessary. Tubes should be firm, but not drum tight. (*Temperature variance*) Inflate floor. (*This will insulate you from the*

apply to general aviation ditchings.

The numbers don't lie, and only emphasize the importance, and benefits, of prior training. One way in which the Airman Education Programs is introducing crewmembers on how to egress a submerged aircraft is by use of its Shallow Water Egress Trainer (SWET). The SWET is intended to provide students with an opportunity to practice an underwater egress in a controlled environment. Although the chances that you will ever have to ditch are remote, training will increase your chances of survival.



7-1 Shallow Water Egress Trainer (SWET)

Performing a successful underwater egress actually begins with preparation. You should know how to move through the fuselage of your aircraft with your eyes closed. Reference physical objects that will lead you to exits without having to rely on sight. These objects must be fixed to the aircraft so that they will not be altered or moved during the ditching. It is also a good idea to use items that provide a grip, since you will be pulling yourself towards, as opposed to swimming to, the exit.

If an actual ditching does occur it is extremely important for you to hold the proper brace position throughout the ditching, until the aircraft has ceased all violent motion. This will help to protect the body from flailing injuries as well as reduce the effects of disorientation. As the water movement slows within the fuselage you should be thinking of your reference points. However, you should not reach for your designated reference point until the aircraft has settled.

You should take a breath of air as soon as you sense any rollover motion of the fuselage. You should not take too large of a breath so as to overfill the lungs, this will make it difficult to maintain the brace position.

Once you have become inverted, you will find it easier to stay orientated by maintaining the proper brace position. You will also need to focus on your pre-planned exit route and remember the location of the reference points you have chosen. Sit up straight in your seat.

You should use a predetermined body part such as a knee to locate your reference point. Slide one hand to the predetermined location and then onto the reference point. If this is near the exit door, or hatch, release the hatch at this time. You should then grab the exit frame with that hand. Once you have grabbed the exit frame do not let go, this is your navigation system for exiting the airframe.

8. Swell Period. The time interval between the passage of two successive crests at the same spot in the water, measured in seconds.

9. Swell Velocity. The speed and direction of the swell with relation to a fixed reference point, measured in knots. There is little movement of water in the horizontal direction. Swells move primarily in a vertical motion, similar to the motion observed when shaking out a carpet.

10. Swell Direction. The direction *from* which a swell is moving. This direction is not necessarily the result of the wind present at the scene. The swell may be moving into or across the local wind. Swells, once set in motion, tend to maintain their original direction for as long as they continue in deep water, regardless of changes in wind direction.

11. Swell Height. The height between crest and trough, measured in feet. The vast majority of ocean swells are lower than 12 to 15 feet, and swells over 25 feet are not common at any spot on the oceans. Successive swells may differ considerably in height.

c. In order to select a good heading when ditching an aircraft, a basic evaluation of the sea is required. Selection of a good ditching heading may well minimize damage and could save your life. It can be extremely dangerous to land into the wind without regard to sea conditions; the swell system, or systems, must be taken into consideration. Remember one axiom- ***AVOID THE FACE OF A SWELL.***

1. In ditching parallel to the swell, it makes little difference whether touchdown is on the top of the crest or in the trough. It is preferable, however, to land on the top or back side of the swell, if possible. After determining which heading (and its reciprocal) will parallel the swell, select the heading with the most into the wind component.

2. If only one swell system exists, the problem is relatively simple-even with a high, fast system. Unfortunately, most cases involve two or more swell systems running in different directions. With more than one system present, the sea presents a confused appearance. One of the most difficult situations occurs when two swell systems are at right angles. For example, if one system is eight feet high, and the other three feet, plan to land parallel to the primary system, and on the down swell of the secondary system. If both systems are of equal height, a compromise may be advisable-select an intermediate heading at 45 degrees down swell to both systems. When landing down a secondary swell, attempt to touch down on the back side, not on the face of the swell.

3. If the swell system is formidable, it is considered advisable, in landplanes, to accept more crosswind in order to avoid landing directly into the swell.

4. The secondary swell system is often from the same direction as the wind. Here, the landing may be made parallel to the primary system, with the wind and sec-

contact with the water, it may make several impacts or skips across the water. Never unstrap from your seat until the aircraft has come to a complete stop. This is especially true if the aircraft flips, or goes underwater.

IMPOSING FACTORS

Injury, panic and disorientation are problems that could cause a great deal of difficulty in egressing the aircraft. Any of these, if not dealt with, can lead to a survivable ditching becoming an unsuccessful egress. In other words, you may survive the ditching but not the egress due to your inability to exit the aircraft.

Obviously injury is something that should be taken into consideration. You can greatly reduce your chances of injury by assuming the proper brace position. This means that seats should not only be aft, but up as well. This allows the seat to absorb a portion of the impact loads. You should also sit as erect in your seat as possible while placing your head firmly against the headrest. You should also place your hands in your lap while tucking your elbows in tightly. Your feet should be placed flat on the floor.

The pilot in command will not be able to put his/her hand in their lap. They should, if able, keep from wrapping their thumb around the controls. It will be better to keep the thumb parallel to the other fingers.

One concern with any injury is that it may lead to shock. If this occurs you may be unable to react to the situation. You must make up your mind to survive at all cost regardless any pain that may exist. This requires focus on the egress rather than the injury and pain.

UNDERWATER EGRESS

It may sound awkward but you can act too hastily while trying to egress. If you panic and react too hastily during a ditching you may actually cause more harm than good. For instance, if you try to release your harness too early you could create a situation that is more disorientating than waiting a couple of seconds for all violent motion to stop. It won't be easy, but the calmer you can remain the easier your egress will become. There is a good chance disorientation will be a factor due to the limited vision underwater. You must rely on physical reference points that you can feel. You will more than likely have to "feel" your way out of the aircraft as opposed to "seeing" your way out.

The U.S. Navy performed a statistical evaluation on 316 aircraft ditchings that occurred between 1983 and 1988. The findings concluded that 47% of those who survived did so by performing an underwater egress. Although this was a Navy study, the best guess is that similar statistics also

The actual slope of a swell is very gradual. If forced to land into a swell, touchdown should be made just after passage of the crest. If contact is made on the face of the swell, the aircraft may be swamped or thrown violently into the air, dropping heavily into the next swell. If control surfaces remain intact, the pilot should attempt to maintain the proper nose above the horizon attitude by rapid and positive use of the controls.

f. After Touchdown. In most cases drift, caused by crosswind can be ignored; the forces acting on the aircraft after touchdown are of such magnitude that drift will be only a secondary consideration. If the aircraft is under good control, the "crab" may be kicked out with rudder just prior to touchdown. This is more important with high wing aircraft, for they are laterally unstable on the water in a crosswind and may roll to the side in ditching.

REFERENCE-

This information has been extracted from Appendix H of the "National Search and Rescue Manual."

Before ditching the aircraft, there are some fundamental steps to be considered:

Hatches – Upon impact with the water the airframe may twist and warp, impeding egress due to hatch impingement. However, some experts feel that this will not affect the emergency exits, since the frame is reinforced around them. It is suggested that if you are in a pressurized aircraft you follow the aircraft manufacturer's pre-ditch checklist regarding "pulling" of hatches. If you are in an aircraft that is not pressurized you should prop the door open with something to keep it from being jammed shut.

All Loose Items Stowed - This includes hatches, equipment, anything that could become a projectile. But most importantly, this means you! Make sure that you and all crewmembers are strapped in. When the aircraft makes

ondary system at an angle. There is a choice to two directions paralleling the primary system. One direction is downwind and down the secondary swell, and the other is into the wind and into the secondary swell, the choice will depend on the velocity of the wind versus the velocity and height of the secondary swell.

d. The simplest method of estimating the wind direction and velocity is to examine the wind streaks on the water. These appear as long streaks up and down wind. Some persons may have difficulty determining wind direction after seeing the streaks on the water. Whitecaps fall forward with the wind but are overrun by the waves thus producing the illusion that the foam is sliding backward. Knowing this, and by observing the direction of the streaks, the wind direction is easily determined. Wind velocity can be estimated by noting the appearance of the whitecaps, foam and wind streaks.

1. The behavior of the aircraft on making contact with the water will vary within wide limits according to the state of the sea. If landed parallel to a single swell system, the behavior of the aircraft may approximate that to be expected on a smooth sea. If landed into a heavy swell or into a confused sea, the deceleration forces may be extremely great-resulting in breaking up of the aircraft. Within certain limits, the pilot is able to minimize these forces by proper sea evaluation and selection of ditching heading.

2. When on final approach the pilot should look ahead and observe the surface of the sea. There may be shadows and whitecaps-signs of large seas. Shadows

and whitecaps close together indicate short and rough seas. Touchdown in these areas is to be avoided. Select and touchdown in any area (only about 500 feet is needed) where the shadows and whitecaps are not so numerous.

3. Touchdown should be at the *lowest* speed and rate of descent which permit safe handling and optimum nose up attitude on impact. Once first impact has been made, there is often little the pilot can do to control a landplane.

e. Once pre-ditching preparations are completed, the pilot should turn to the ditching heading and commence let-down. The aircraft should be flown low over the water, and slowed down until ten knots or so above stall. At this point, additional power should be used to overcome the increased drag caused by the nose up attitude. When a smooth stretch of water appears ahead, cut power, and touchdown at the best recommended speed as fully stalled as possible. By cutting power when approaching a relatively smooth area, the pilot will prevent overshooting and will touchdown with less chance of planing off into a second uncontrolled landing. Most experienced seaplane pilots prefer to make contact with the water in a semi-stalled attitude, cutting power as the tail makes contact. This technique eliminates the chance of misjudging altitude with a resultant heavy drop in a fully stalled condition. Care must be taken not to drop the aircraft from too high altitude or to balloon due to excessive speed. The altitude above water depends on the aircraft. Over glassy smooth water, or at night without sufficient light, it is very easy, for even the most experienced pilots to misjudge alti-

tude by 50 feet or more. Under such conditions, carry enough power to maintain nine to twelve degrees nose up attitude, and 10 to 20 percent over stalling speed until contact is made with the water. The proper use of power on the approach is of great importance. If power is available on one side only, a little power should be used to flatten the approach; however, the engine should not be used to such an extent that the aircraft cannot be turned against the good engines right down to the stall with a margin of rudder movement available. When near the stall, sudden application of excessive unbalanced power may result in loss of directional control. If power is available on one side only, a slightly higher than normal glide approach speed should be used. This will insure good control and some margin of speed after leveling off without excessive use of power. The use of power in ditching is so important that when it is certain that the coast cannot be reached, the pilot should, if possible, ditch before fuel is exhausted. The use of power in a night or instrument ditching is far more essential than under daylight contact conditions.

1. If no power is available, a greater than normal approach speed should be used down to the flare-out. This speed margin will allow the glide to be broken early and more gradually, thereby giving the pilot time and distance to feel for the surface - decreasing the possibility of stalling high or flying into the water. When landing parallel to a swell system, little difference is noted between landing on top of a crest or in the trough. If the wings of aircraft are trimmed to the surface of the sea rather than the horizon, there is little need to worry about a wing hitting a swell crest.